

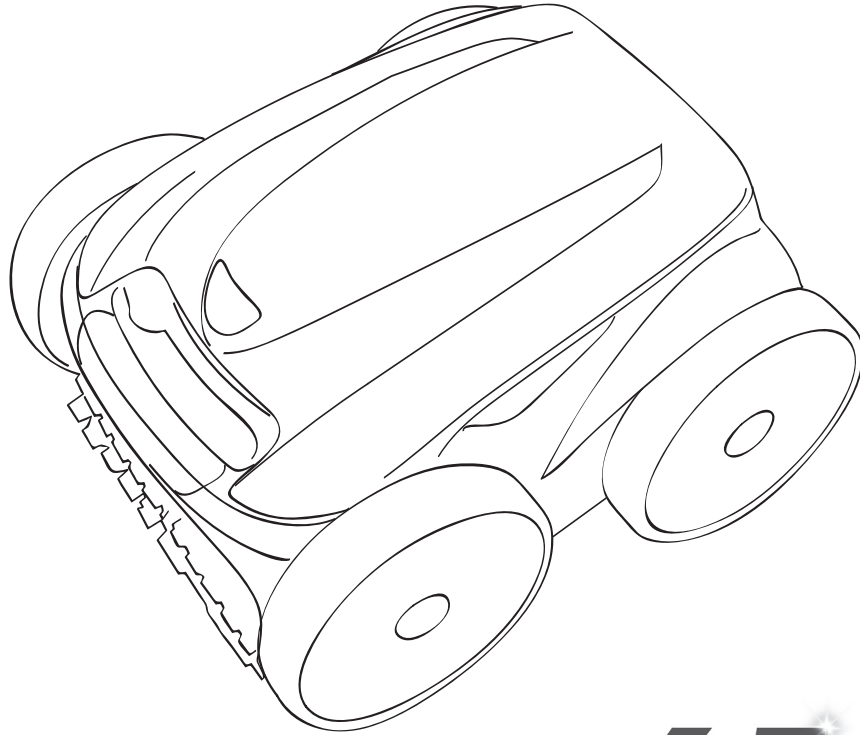

ZODIAC®

OWNER'S MANUAL



VX65 iQ

**Vortex-Pro
Robotic Pool Cleaner**

TYPE EC15--

**iAquaLink™
CONTROL**

WARNING

FOR YOUR SAFETY - For anything other than the routine cleaning and maintenance described in this manual, this product must be serviced by a pool technician who is licensed and qualified in pool equipment by the jurisdiction in which the product will be installed where such state or local requirements exist. In the event no such state or local requirement exists, the maintainer must be a professional with sufficient experience in pool equipment installation and maintenance so that all of the instructions in this manual can be followed exactly. Improper installation and/or operation will void the warranty.

THANK YOU FOR PURCHASING THE ZODIAC VORTEX CLEANER.

YOUR ZODIAC ROBOTIC CLEANER HAS BEEN DESIGNED AND MANUFACTURED TO BE EASILY INSTALLED AND TO PROVIDE LOW MAINTENANCE OPERATION. PRIOR TO INSTALLING YOUR NEW ZODIAC CLEANER, PLEASE DO THE FOLLOWING:

- 1) Complete and return the warranty registration online at www.zodiac.com.au
- 2) Record your purchase information on the spaces provided below.
- 3) Attach your invoice (or a copy) to this page.

Should your product require repair under warranty, please contact Zodiac Customer Care 1300 763 021.

RECORD YOUR ZODIAC CLEANER DATA HERE:

Date of Purchase _____ Purchased From _____ Serial Number: _____
(located on machine head)

City _____ State _____ Post Code _____

Table of Contents

1	Important Safety Instructions	4	6	iAquaLink Control	19
				The Home Screen	19
2	Cleaner Specifications.....	5		Start / Stop Cleaning and Adjust Cleaning Time.....	20
	General Specifications.....	5		Set Cleaning Mode	20
3	Assembly	6		Remote Control	20
	Contents	6		Lift System.....	21
	Assemble the Transport Caddy	7		Program or Cancel Recurring Cleaning Schedules....	21
	Attach the Control Unit to the Caddy.....	10		In-App Error Messages and Troubleshooting	22
	Connect to a Power Source.....	11		System Settings.....	22
4	General Cleaner Operation.....	13	7	Cleaning, Storage, and Maintenance	23
	Install and Submerge the Cleaner	13		Cord Tangling	23
	Using the Control Unit	16		Replacing Wear Parts.....	27
	Start / Stop Cleaning	16		Replacing Tyres.....	29
	Lift System.....	17	8	Troubleshooting	32
5	Installing iAquaLink™	17		Error Codes	32
	Download the App	17		General Troubleshooting	33
	Sign Up and Log In.....	18		Dismissing an Error Code.....	34
	Configure the System	18		iAquaLink Troubleshooting	34
				Conformity	36

Vortex Pro VX65 iQ Robotic Pool Cleaner is covered under a 3 Year Manufacturers Limited Warranty.

3 year manufacturers warranty or 1200 running hours on the motor block. Zodiac provides coverage until either yearly or total running hours figure is reached, whichever comes first.

1 year manufactures warranty on filter canister.

The 3 Year Limited Warranty Period starts on the date of purchase. Retain proof of purchase or note serial number for warranty claim.

To check running hours of the motor block, simply access “settings” (the cog in the upper right hand corner) via the iAquaLink app. Click through “info” and view “total running hours”.

1 Important Safety Instructions

Congratulations on purchasing the Zodiac Robotic Cleaner. Please read through the entire manual before installing your new robotic pool cleaner. Your cleaner must be installed and operated as specified.

⚠ WARNING

Failure to comply with the following warnings can increase risk of fire or electrocution which can result in property damage and serious injury, including loss of life.

PREVENT ELECTRICAL SHOCK

To reduce risk of electrical shock:

- The cleaner is to be installed in accordance with the relevant requirements of the Australian wiring rules AS/NZS 3000. Also refer to the installation instructions relating to the swimming pool equipment for which the cleaner will be an integral part. The cleaner is to be supplied through a Residual Current Device (RCD) with a rated residual operating current of 30mA.
- Do not enter pool while the robotic cleaner is in water.
- Do not bury cord. Locate cord so as to prevent it from being damaged by lawn mowers, hedge trimmers and other equipment.
- To reduce the risk of electrical shock, do not use the robotic cleaner or control unit if the cord is worn or damaged. Contact Zodiac Customer Care Service 1300 763 021 immediately for proper servicing and replacement of the damaged cord.
- Double insulation—For continued protection against possible electric shock, use only identical replacement parts when servicing. Do not attempt repair of the robotic cleaner, control unit, power cord, or floating cable.
- Use only the power supply provided with the product.
- NEVER OPEN CONTROL UNIT.
- DO NOT USE AN EXTENSION CORD TO CONNECT THE UNIT TO ELECTRIC SUPPLY; PROVIDE A PROPERLY LOCATED APPROVED ELECTRICAL OUTLET. THE CONTROL UNIT SHOULD BE PLACED NEAR THE APPROVED RECEPTACLE BOX.

PREVENT CHILD INJURY AND DROWNING

- To reduce the risk of injury, do not permit children or persons with reduced physical, sensory or mental capabilities, or lack of experience and knowledge to operate this product.
- Do not let anyone, especially small children, sit, step, lean, or climb on any equipment installed as part of your pool's operational system.



SAVE THESE INSTRUCTIONS

⚠ CAUTION

Failure to comply with the following warnings could cause damage to pool equipment or personal injury.

- The robotic cleaner must be installed and operated as specified.
- This product is intended for use with permanently-installed pools. Do not use with storable pools. A permanently-installed pool is constructed in or on the ground or in a building such that it cannot be readily disassembled for storage. A storable pool is constructed so that it is capable of being readily disassembled for storage and reassembled to its original integrity.
- Clean the filter canister in the Vortex cleaner after each use.
- Do not use the product in your pool if the water temperature is above 35° C (95° F) or below 13° C (55° F).

USE OF THE ZODIAC ROBOTIC CLEANER IN A VINYL LINER POOL

Certain vinyl liner patterns are particularly susceptible to rapid surface wear or pattern removal caused by objects coming into contact with the vinyl surface, including pool brushes, pool toys, floats, fountains, chlorine dispensers, and automatic pool cleaners. Some vinyl liner patterns can be seriously scratched or abraded simply by rubbing the surface with a pool brush. Ink from the pattern can also rub off during the installation process or when it comes into contact with objects in the pool. Zodiac Group Australia Pty. Ltd. is not responsible for, and the Limited Warranty does not cover, pattern removal, abrasion or markings on vinyl liners.

2 Cleaner Specifications

General Specifications

The general specifications for the cleaner are as follows:

Control box supply voltage 	220-240 VAC, 50 Hz; short circuit-proof safety isolating type
Supply voltage	30 V DC
Installed load	150 W max
Cable length	21m
Cleaner size (WxDxH)	43 x 48 x 27 cm
Weight of Cleaner	9.5 kg
Packed weight	19 kg
Filtration	All-purpose filter canister
Cycle lengths	Variable programming for cleaning floor, walls, and waterline (from 1.5 hours - 3.0 hours).

The cleaner is a double-insulated product. A double-insulated electrical appliance is one which has been designed in such a way that it does not require a safety connection to ground. The basic requirement for double-insulation is that no single failure can result in dangerous voltage becoming exposed so that it might cause an electric shock and that this is achieved without relying on an earthed (grounded) metal casing. This is achieved by having two (2) layers of insulating material surrounding live parts or by using reinforced insulation. Therefore, devices having double-insulated construction, such as this cleaner, do not utilize a grounded (three-prong) cord/plug.

3 Assembly

Contents

The packaging should contain the following items:

- Vortex cleaner and floating cable
- Control unit
- Manual, Quick Start Guide, and Warranty Card
- Transport and storage caddy assembly components (Figure 1)
 - a. handle frame
 - b. support blocks (x 2)
 - c. wheels (x 2)
 - d. wheel locking clips (x 2)
 - e. wheel axle / hubcap (x 2)
 - f. base unit
 - g. cleaner hook
 - h. caddy handle

Figure 1. Transport Caddy Assembly Components

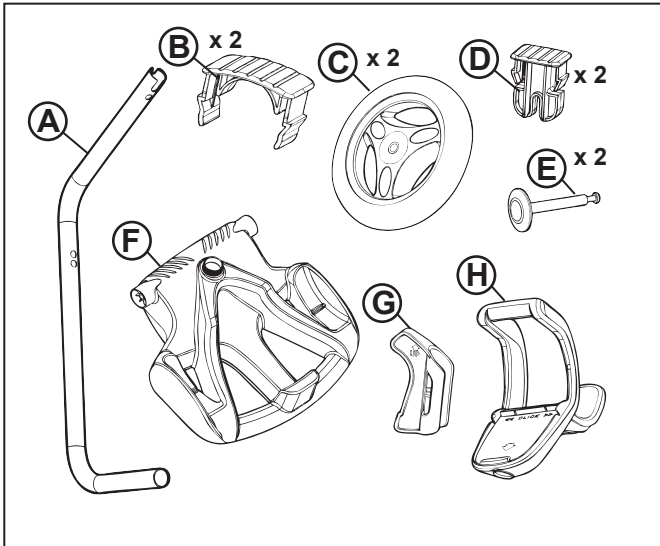

When unpacking the cleaner and its components:

- Check to make sure each component is in the box.
- Check cleaner and components for damage during transport.
- If there are any missing parts or damage, contact Technical Support at 1300 763 021.

Assemble the Transport Caddy

1. Unscrew the handnut from the base (Figure 2).

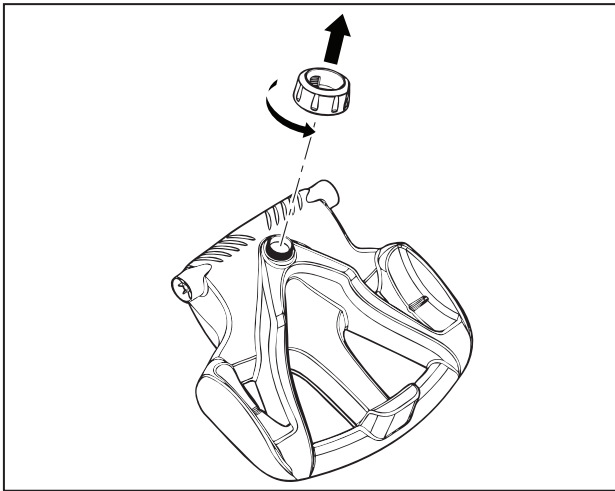

Figure 2. Remove Handnut from Base Unit

2. Insert the metal handle frame tubing into the base with notch end at the top, then rotate so the bends are away from you. (Figure 3).
3. Push base down (Figure 3) so the metal handle frame is seated in the recess on the underside of the base.

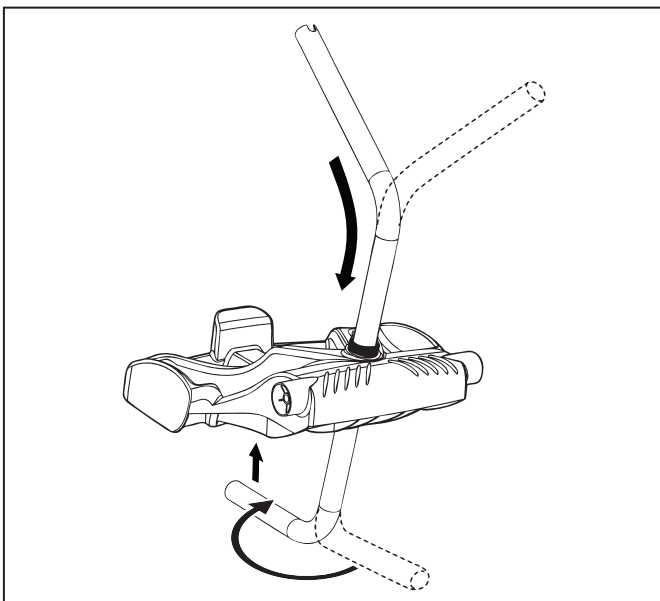

Figure 3. Connect Metal Frame to Base Unit

4. Slide the handnut over the tube and twist to tighten onto base unit (Figure 4).

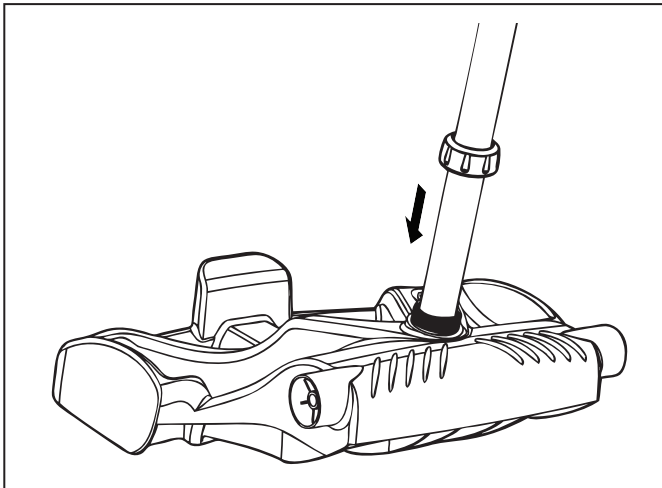

Figure 4. Twist Handnut to Secure Frame

5. Snap two (2) support blocks into place (Figure 5).
6. Slide axle and hubcap piece through center of wheel and attach to base unit. Snap locking clip into place to secure wheel. Repeat to attach both wheels (Figure 5).

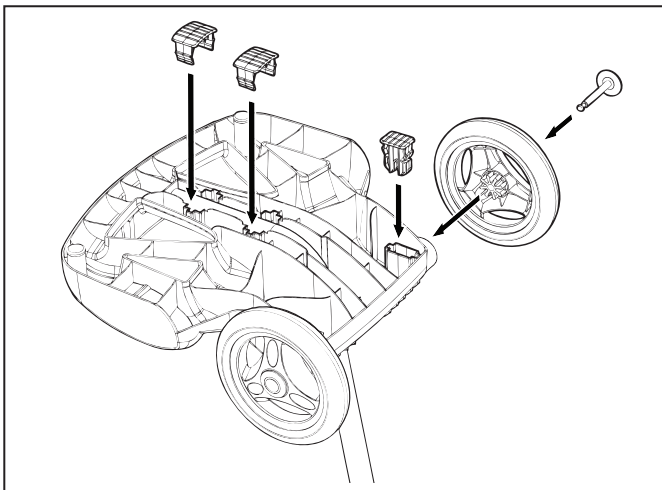

Figure 5. Snap in Support Blocks and Attach Wheels

7. Slide the control unit base / caddy handle attachment down over the metal tubing until it snaps into place. (See Figure 6).

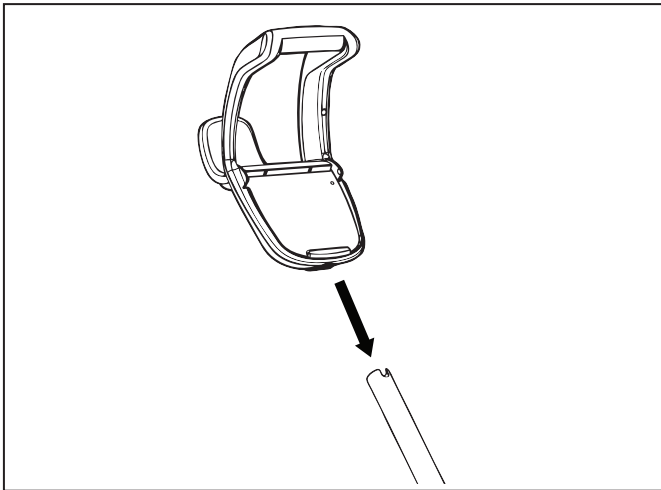

Figure 6. Attach Caddy Handle

8. Align cleaner hook pins with the top holes in the handle tube and snap into place (Figure 7).

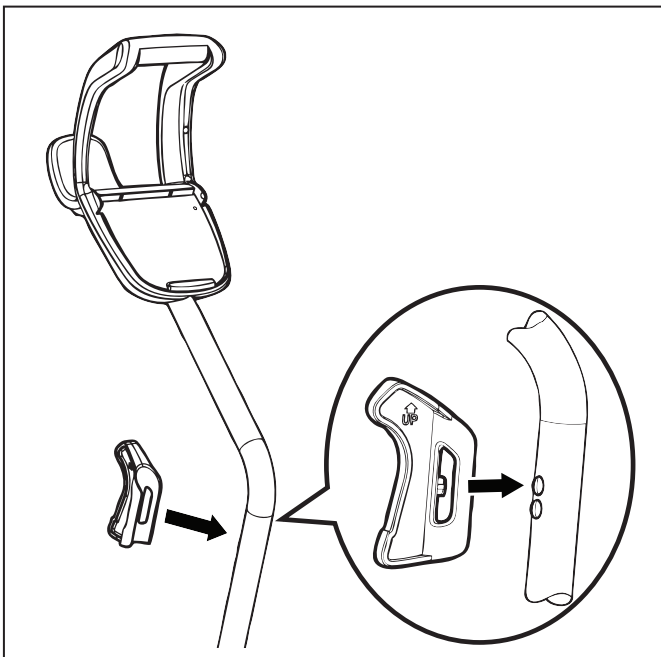

Figure 7. Snap Cleaner Hook into Place

Attach the Control Unit to the Caddy

1. Align the bottom of the control unit with the notch at bottom of the control unit hook on the caddy (Figure 8).

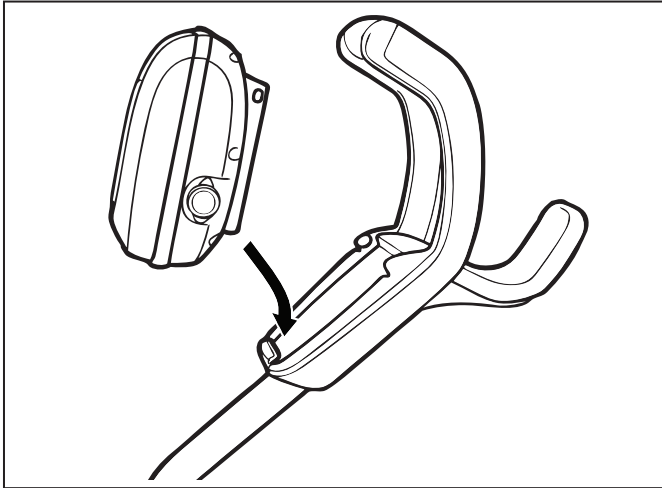

Figure 8. Align Control Unit with Caddy Hook

2. Press control unit onto the caddy hook until it snaps and locks into position (Figure 9).

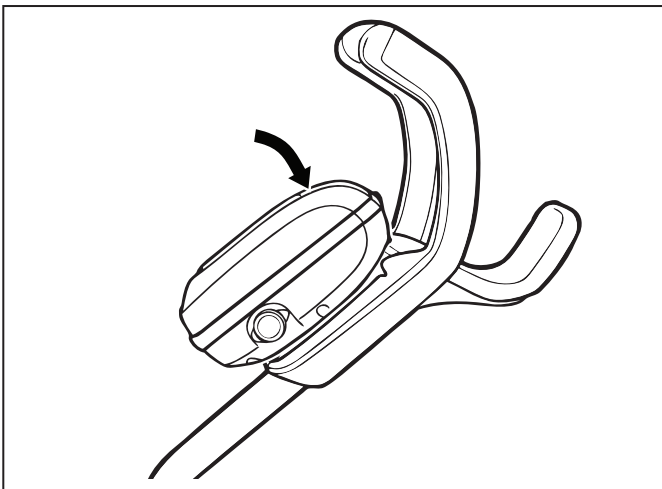

Figure 9. Attach the Control Unit onto Caddy

Connect to a Power Source

⚠ WARNING

Failure to comply with the following warnings can increase risk of fire or electrocution which can result in property damage and serious injury, including loss of life.

PREVENT ELECTRICAL SHOCK

- Keep the control unit at least 3.5 m from the edge of the pool.
- The cleaner is to be installed in accordance with the relevant requirements of the Australian wiring rules AS/NZS 3000. Also refer to the installation instructions relating to the swimming pool equipment for which the cleaner will be an integral part. The cleaner is to be supplied through a Residual Current Device (RCD) with a rated residual operating current of 30mA.
- Do not use an extension cord to connect the control unit.
- Do not allow anyone to swim while the cleaner is in the pool.
- The control unit is water-resistant, not waterproof. In order to prevent electrocution, never submerge the control unit or leave exposed to inclement weather.

1. Unscrew the protective cap for the floating cable from the side of the control unit by turning counter-clockwise (Figure 10).

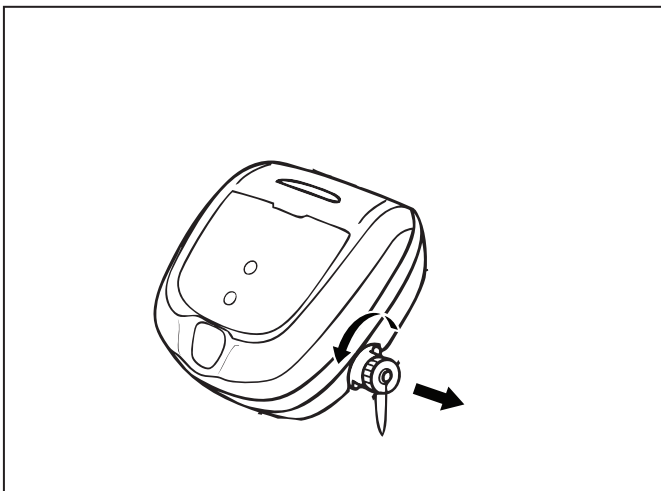

Figure 10. Remove Protective Cap

2. Grip the notched end of the floating power cable, insert into the control unit, and turn clockwise to tighten. (Figure 11.)

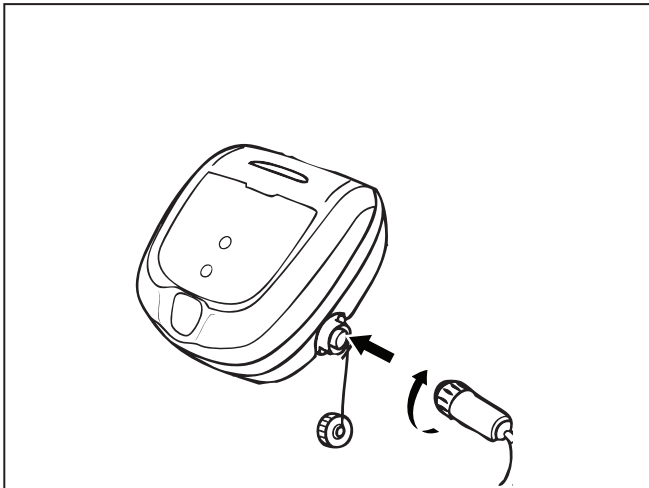
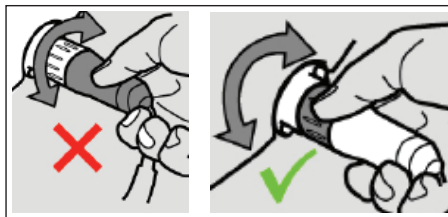
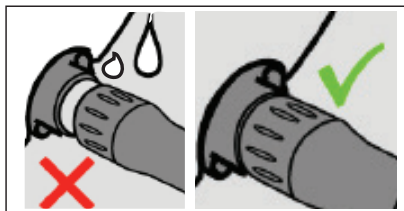

Figure 11. Connect Floating Cable

NOTE: To avoid damaging the power cable, do not try to twist the entire cable housing (see below).



NOTE: To avoid exposing the power cable connector pins to water, be sure the connector is screwed in all the way and there is no gap. (see below).



4 General Cleaner Operation

⚠ CAUTION

- To prevent damage to the cleaner, be sure to adhere to the following guidelines:
- Remove the cleaner from the pool after the cleaning cycle is completed.
- Store on the caddy out of direct sunlight or inclement weather.
- Never lift the cleaner out of the pool by the floating cable. Always use the lift feature to remove cleaner from the pool.
- Take additional care when lifting the cleaner out of the pool. It becomes heavier when filled with water.
- Always remove the cleaner from pool when super chlorinating or adding acid.
- Do not handle cleaner while it is in operation.

IMPORTANT

- Always make sure the cleaner head is fully submerged before you begin operation.
- Clean the filter canister after each cleaning cycle.
- Do not leave your cleaner in the pool on a permanent basis.
- At the end of each cycle, remove the cleaner from the pool.
- Start at the cleaner head and untangle any coils in the cable before storing the cleaner.

The Vortex robotic cleaner includes a safety feature that automatically stops the cleaner if it is powered on but not submerged in water. For pools equipped with a beach area, this safety feature is programmed to drive the cleaner in reverse and back into the pool when the impeller is out of the water.

Zodiac recommends not exceeding 3 cleaning cycles per week.

Install and Submerge the Cleaner

1. With the control box plugged into a power outlet, spread the floating cable across the pool deck until you reach the middle of the pool length.
2. At the center point, submerge the cleaner in the pool and hold in the vertical position to release any air trapped inside. (Figure 12).

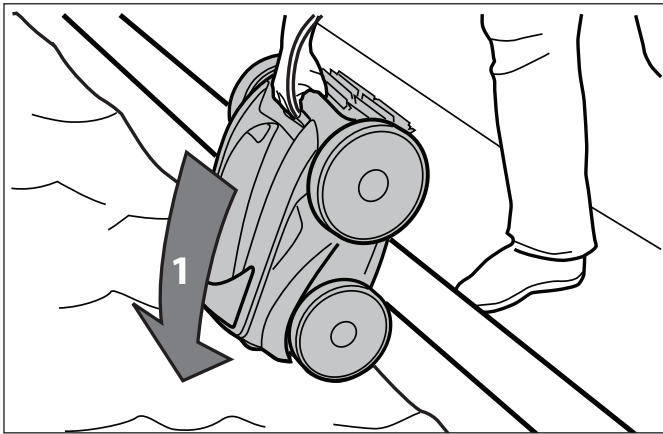

Figure 12. Submerge the Cleaner Vertically

3. Ensure the unit sinks to the bottom of the pool and does not float (Figure 13).

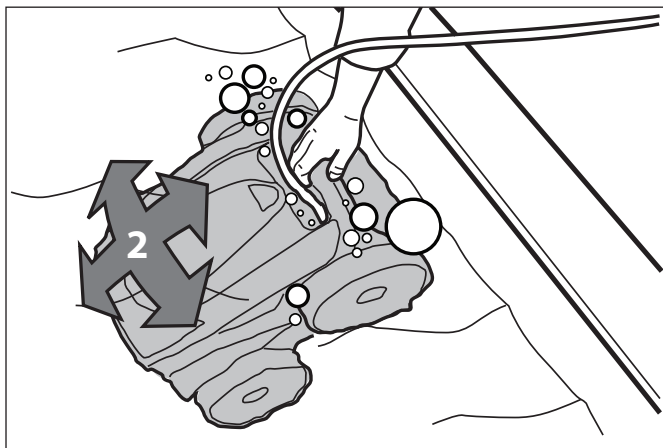

Figure 13. Cleaner Sinking to the Bottom of the Pool

4. Place only enough floating cable in the water to reach the farthest end of your pool from the central point. Spread out the floating cable ensuring there are no kinks or coils in the cable (Figure 14).

NOTE: For optimal patterning and reduced tangling, the floating cable should enter the water near the middle of the pool length. Only place enough cable in the water to reach the farthest point in the pool (see Figure 14).

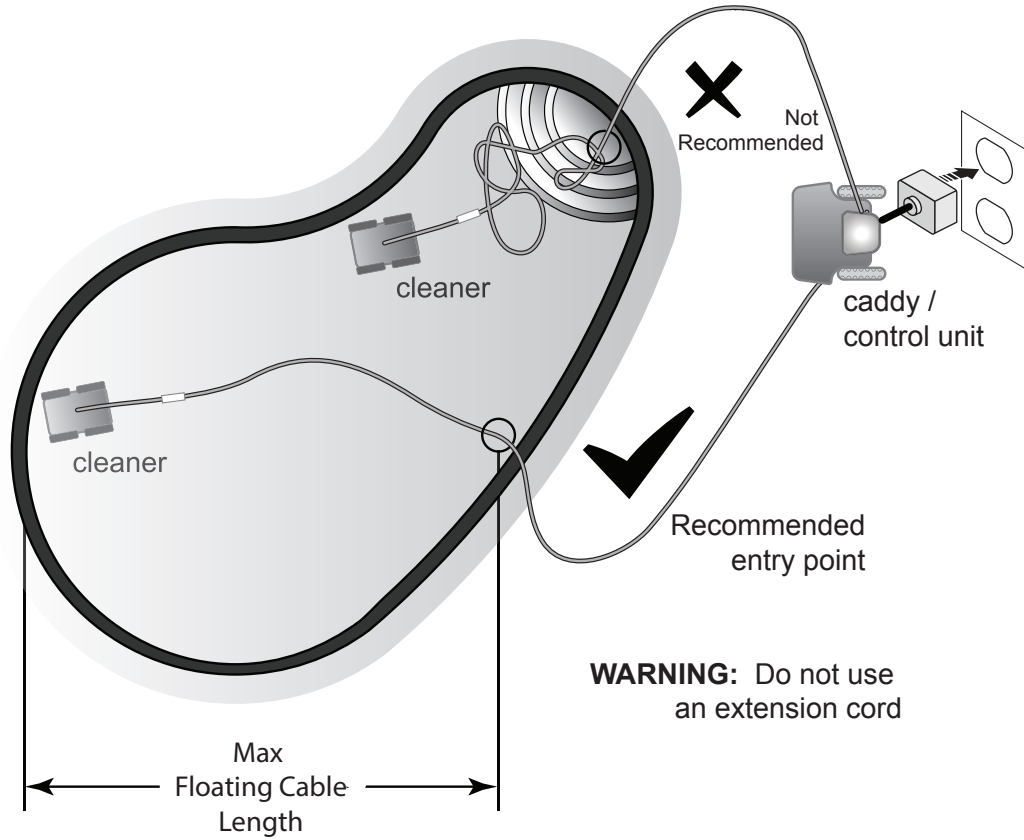

Figure 14. Pool Entry Point for Optimal Patterning

Using the Control Unit

The control unit can be used to initiate basic cleaning features and to connect the device to home Wi-Fi. For more information on connecting your cleaner to Wi-Fi functions, see section 5, Installing iAquaLink™.

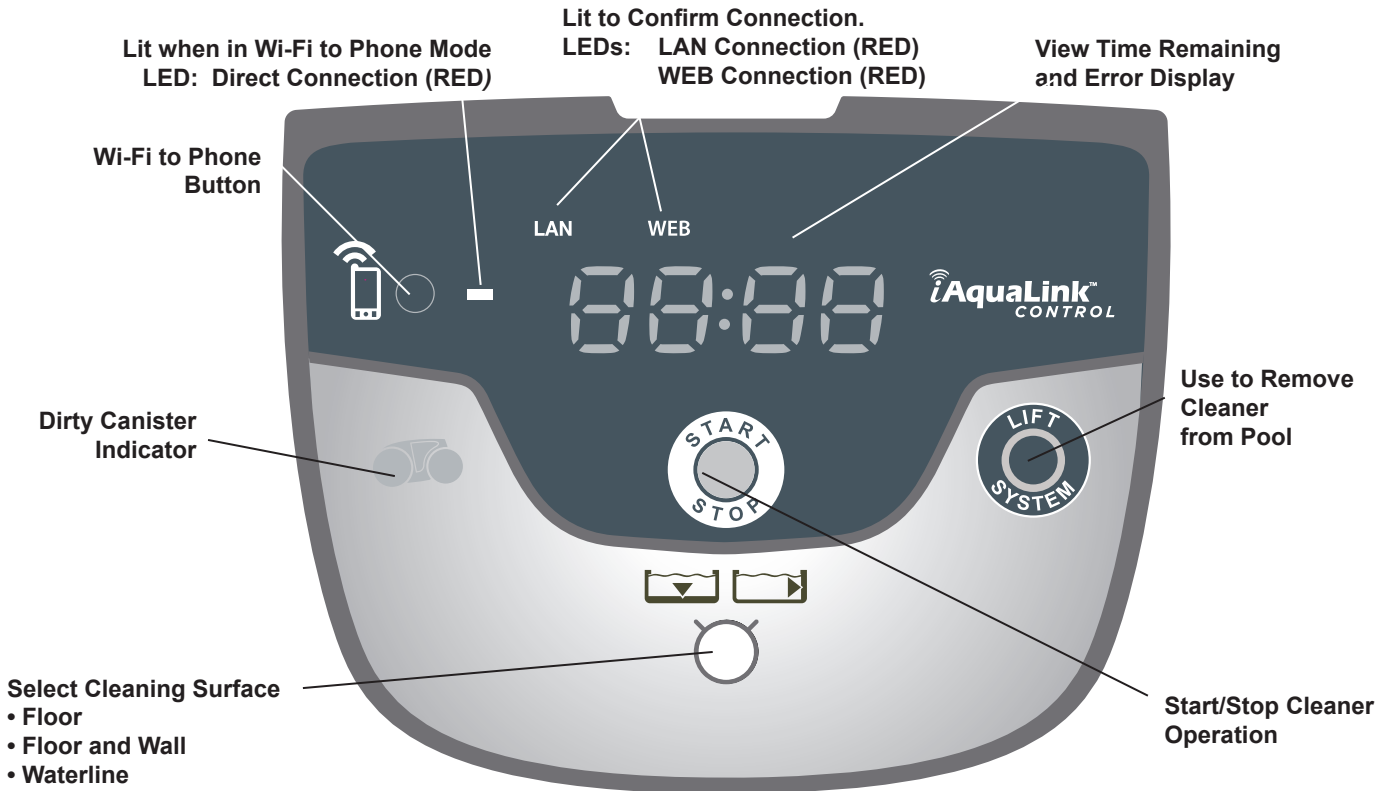









Figure 15. Cleaner Control Unit

Start / Stop Cleaning

The factory default cleaning surface setting is Floor and Wall .

Use  to change cleaning surface setting.

Toggle between: Floor Only , Floor and Wall   and Waterline only .

With cleaner submerged in the water, press  to begin operation.



The control box will display the time remaining for the selected cycle in hours and minutes.

NOTE: The control box automatically goes into standby mode after 10 minutes and the display screen turns off. Press any key to exit standby mode and view remaining cycle time. Cleaner will continue to function in standby mode.

Press  to interrupt and cancel an in-progress cleaning cycle.

Lift System

The proprietary Lift Removal System is designed to assist in retrieving the robot from the pool. Lift System can be activated at any time during or after a cleaning cycle.

1. Press  to begin the automated procedure.
The screen displays  when the Lift System is in operation.
NOTE: To stop the procedure at any time, press and release the button again.
2. Next, Press and HOLD  to rotate the cleaner. Once the cleaner is facing the wall of your choice for retrieval, release the button.
3. Cleaner will drive forward and up the wall it is facing. It will wait at the water line to be retrieved.
4. When in reach, grab the cleaner handle and begin to pull cleaner out of the water. The cleaner will quickly expel water to allow for lighter, easier removal.

NOTE: Never lift the cleaner out of the pool by the floating cable.

5 Installing iAquaLink™



The iAquaLink app is available for download from the iTunes or Google Play store.

With iAquaLink Control, you can connect to your robotic cleaner from anywhere, anytime with access to advanced features, additional programming options and troubleshooting advice.

Before you begin installation, make sure you have the following:

- Robotic Cleaner submerged in the pool.
- Control Unit connected and plugged into an approved power outlet.
- Wi-Fi enabled smart device (phone or tablet)
- Wi-Fi router with sufficient signal strength at the Control Box
- ***IMPORTANT:*** Have your Wi-Fi network password available.

Download the App

Install or Update the **iAquaLink** app from the iTunes or Google Play Store.

Once the download is complete, select the **iAquaLink icon** on your smart device to open the app.

Sign Up and Log In

Click **Sign Up** to create a new user account. Or, if you previously set up an iAquaLink account, click **Log In** to access your systems.

Complete all required fields in the Account Set Up page and agree to the Terms and Conditions.

Configure the System

1. On the My Systems page, click **+** in the upper right-hand corner to add a system.
2. Choose "Robotic Cleaner" from the list.
3. Select **Wi-Fi to Phone** to continue setup, unless you previously received an Invite Code via text or email.
4. On the Control Unit, press  (Wi-Fi to Phone button).

A light on the control unit indicates a signal being sent to your smart device.

NOTE: If the Wi-Fi to Phone LED turns off before setup is complete, press the Wi-Fi to Phone button on the control box and start again.

5. Continue with the on-screen instructions on your smart device.
6. When Wi-Fi networks are displayed, choose "RoboticCleaner-•••"
(••• will be a code unique to the cleaner you are connecting to.)
7. Once your phone and the device are communicating, select the **Timezone**.
Choose your country and nearest city.
8. Next, choose your **Pool Shape**.
These settings ensure that programming and cleaning patterns are optimized for your location.
9. Click **Next** to find and connect the cleaner signal to your home router.
10. Choose your home router from the list of found Wi-Fi networks
11. Enter your Wi-Fi password and select **Join**.
When your router and cleaner are communicating, the LAN and WEB lights illuminate on the control unit and the light next to the Wi-Fi to Phone icon turns off.

NOTE: The searching screen may take a few minutes to find your router. If you receive an error you may have a weak router signal at the location of your control box OR you may have entered an incorrect Wi-Fi password. In the case of a weak router signal, consider installing a Wi-Fi extender to boost your signal strength. (See iAquaLink Troubleshooting section.)

12. On your smart device, the **Add to My Systems** page is displayed.
You can choose a name for your cleaner to appear in the My Systems list every time you log in. This is helpful if you have multiple iAquaLink™ connected products that will appear in your My Systems list.

IMPORTANT:

It is recommended that you add the robot to your systems so that it will show up in your system list the next time you connect to the iAquaLink app.

13. On the next screen, click "Select" if you want to be the **Primary User**. The Primary User will have access to all cleaner functions in the app. The Primary User can invite or remove people (family members, service providers etc.) to allow them access to cleaner functions and programming. Click "Skip" if you do not want to be the Primary User.

NOTE: Send Invite Code - you can only send invite codes if you are set up as the Primary User. Sending an invite codes to friends and family will allow them to access the cleaner app functions and programming. If you choose to Skip this step, the Primary User can always send Invite Codes at a later time by accessing the System Settings Screen.

6 iAquaLink™ Control

Once you have downloaded the iAquaLink app and connected the device to Wi-Fi, the iAquaLink app allows for robotic cleaner control from anywhere, anytime with access to advanced features, additional programming options and troubleshooting advice.

⚠ WARNING

Do not enter pool while the robotic cleaner is in water.

The Home Screen

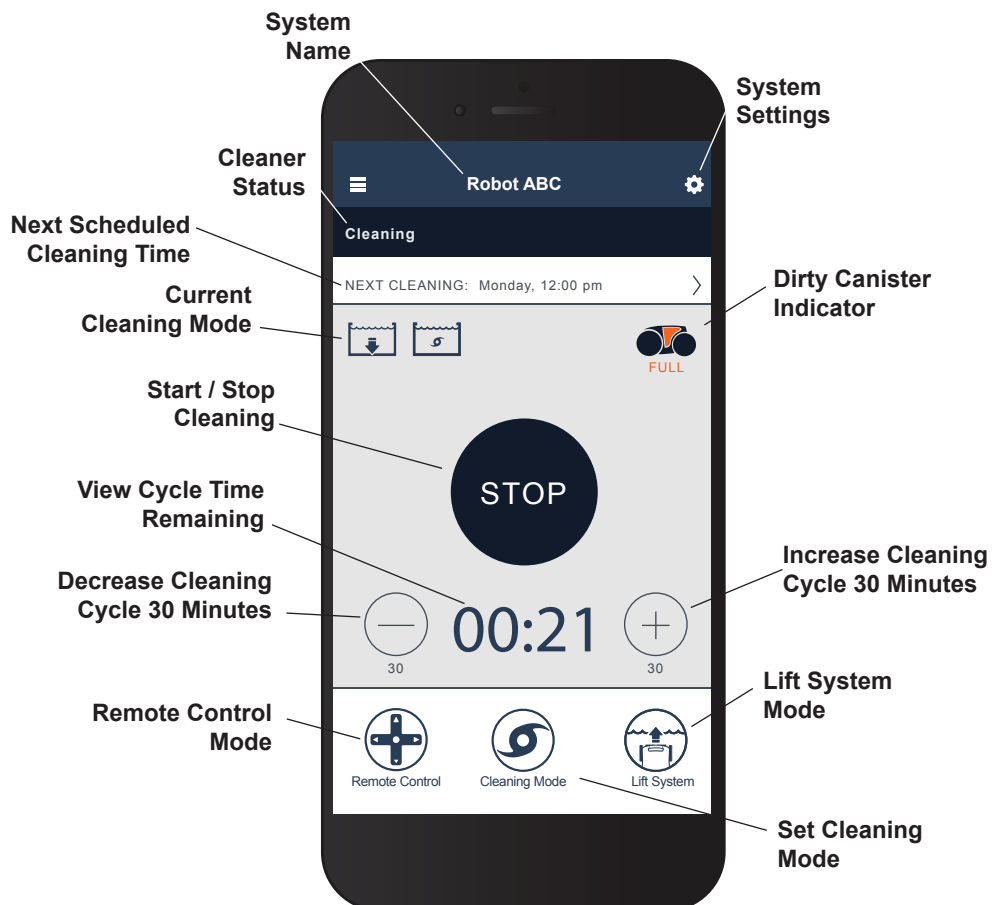

NOTE: Image of screen layout is subject to change due to periodic updates to the app.

Start / Stop Cleaning and Adjust Cleaning Time

NOTE: During system configuration, the chosen pool shape defines robotic patterning cycles/run time

The factory default cleaning surface setting is **Floor and Wall**

1. From the main app screen and with cleaner submerged in the water, press **START** to begin operation.
2. The app displays the time remaining for the selected cycle in hours and minutes.
To increase or decrease the cycle time during cleaning, press the **(+)** and **(-)** buttons.
-Time adjusts up or down in 30 minute increments.
-Minimum run time is 30 minutes.
-Maximum run time is 3 hours 30 minutes.
-The control unit displays the same countdown and cycle setting as the app.
3. Press **STOP** to interrupt and cancel an in-progress cleaning cycle.

Set Cleaning Mode

1. From the main screen, select **Cleaning Mode** to view options.
2. Choose between **Quick Clean**, **Deep Clean**, **Waterline Only**, and **Custom** modes. The selected mode is highlighted.
3. In Custom mode, select the cleaning surface and cleaning intensity from the on-screen icons. Selections will be highlighted.
-Surface choices include, **Floor Only**, **Floor and Wall**, or **Waterline Only**
-Intensity options are **Standard Intensity** or **High Intensity**.
4. Press **Save** to keep settings or **X** to cancel and go back.

NOTE: Cleaning mode will be set for all current or future cleaning cycles unless adjusted on the control box or within the app.

5. Press **X** to leave the Lift System page and return to the main screen.

Remote Control

The cleaner can be directed using your mobile device as a remote control.

IMPORTANT: Only use Remote Control when in view of the cleaner.

1. From the main screen, select **Remote Control**.

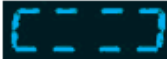
NOTE: When in remote control mode, the control box displays .

2. You may choose to control the robot using **joystick** commands or **directional motion control**.

You can switch between these modes within the app.

Joystick Control - Press the icons to direct the cleaner **forward**, **backward** and to turn **left** or **right**.

Motion Control - Tilt your smart device **up** (backward), **down** (forward), **left** (rotate left), and **right** (rotate right) to direct the cleaner. When you first enter motion control mode, it will automatically calibrate to your hand position. If you want to re-calibrate the positioning, press the icon in the upper left hand corner.

3. To exit Remote Control mode, press **X**.

NOTE: If you experience significant delays between the app command and cleaner response, you may have a weak Wi-Fi signal or other connectivity challenges that interfere with the immediacy of the remote control functions. (For more information, see Using iAquaLink in Wi-Fi to Phone Mode.)

Lift System

The Easy Lift Removal System is designed to assist in retrieving the robot from the pool. Lift System can be activated at any time during or after a cleaning cycle.

IMPORTANT: Only use Lift System when in view of the cleaner.

1. From the main screen, select **Lift System** to enter automated procedure.
2. Use the **left** and **right** arrow icons to rotate the cleaner to face the wall of your choice.
3. Press the **Lift System** icon to drive the cleaner up the wall it is facing. The cleaner will wait at the water line to be retrieved.

NOTE: To stop the procedure at any time, press and release the button again.

4. When in reach, grab the cleaner handle and begin to pull cleaner out of the water. The cleaner will quickly expel water to allow for lighter, easier removal.

NOTE: Never lift the cleaner out of the pool by the floating cable.

5. Press **X** to leave the Set Cleaning Mode page and return to the main screen.

Program or Cancel Recurring Cleaning Schedules

You can program recurring cleaning schedules using iAquaLink™ Control. It is still recommended to remove and clean the filter canister after every cleaning cycle.

1. From the main screen, either select the area titled **Next Cleaning Cycle** or go to **System Settings** and choose **Edit Schedule**.
2. To program a recurring cleaning schedule, select the **day of the week** when you want the cleaner to run.
3. Select a **start time** to begin the cleaning cycle.
You may choose to display the start time in standard or 24-hour time in system settings.
4. Press **Save** to store the cleaning schedule or **Cancel** to discard.
5. Repeat steps 2-4 to program additional recurring cleaning schedules.

NOTE: Only one programmed cleaning cycle can be scheduled each day. The cleaner will attempt to perform a cleaning cycle every week at the day/time it is programmed unless the schedule is changed or canceled. Cleaning cycle duration is determined by the choices made when setting Cleaning Mode.

6. To delete a recurring cleaning schedule, select the scheduled day and press **Delete Schedule** at the bottom of the screen.
7. Press **X** to leave the Edit Schedule page and return to the main screen.
8. The next scheduled cleaning cycle will display near the top of the main screen.

In-App Error Messages and Troubleshooting

If an error occurs, the status bar will show a warning symbol and: "Cleaning Interrupted".

1. Click on the warning symbol to view troubleshooting advice on how to fix the issue.
2. Choose **Clear Error** if you believe you have fixed the problem and want to re-try. Choose **OK** if you want to suspend the cleaner in error mode and work on the troubleshooting fix at a later time.

System Settings

Access System Settings by pressing the gear icon in the upper right hand corner of the app screen.

Using iAquaLink™ in Wi-Fi to Phone Mode

When using Wi-Fi to Phone mode, the smart device and the cleaner control unit are communicating directly rather than using the home router and communicating through the web. If necessary, the iAquaLink app can be used in Wi-Fi to Phone mode to access certain features and provide more immediate connectivity. Wi-Fi to Phone mode will time out after 15 minutes and only one user will be able to access the app when in Wi-Fi to Phone mode.

1. Go to the three bar menu and choose **My Systems**.
2. On the My Systems page, click **(+)** in the upper-right hand corner.
3. Choose **Wi-Fi to Phone**.
4. On the control unit, press  (Wi-Fi to Phone button).
A light on the control unit indicates a signal being sent to your smart device.
5. Continue with the on-screen instructions on your smart device.
6. When Wi-Fi networks are displayed, choose **RoboticCleaner•••**
(••• will be a unique code for the cleaner you are connecting to.)
7. Once your phone and the device are communicating, click **SKIP** in the upper-right hand corner.
8. You will be directed to the main screen of the iAquaLink app.

NOTE: Wi-Fi to Phone mode will time out after 10 minutes.

7 Cleaning, Storage, and Maintenance

⚠ WARNING

To avoid electric shock and other hazards which could result in permanent injury or death, disconnect (unplug) the cleaner from the power source before performing any cleaning and maintenance.

Cord Tangling

Tangling can occur more frequently when the cleaner is not attended to after each cleaning cycle. The tangle-reducing swivel, in addition to proper installation, general maintenance and the following troubleshooting steps can help to avoid cable challenges.

IMPORTANT

Cleaner floating cable may become tangled if correct procedure is not followed after each cleaning cycle.

NOTE: For optimal patterning and reduced tangling, the floating cable should enter the water near the middle of the pool length (Figure 16). Only place enough cable in the water to reach the farthest point in the pool.

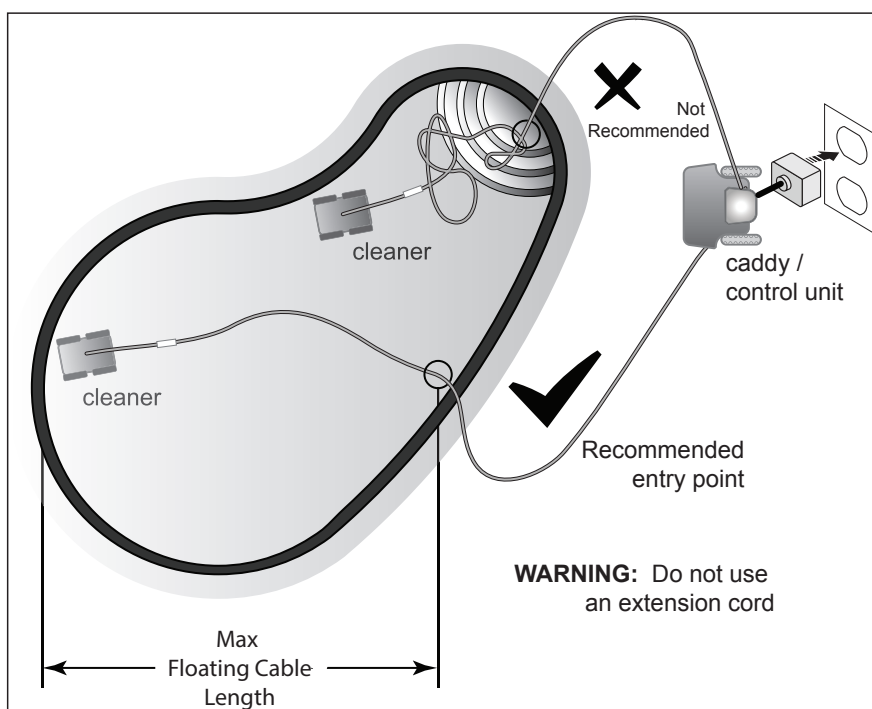

Figure 16. Optimal Entry Point in Pool

If tangling occurs, follow these steps:

1. Remove the cleaner from the pool using the Lift System. When the cleaner is within arm's reach, use the handle to remove from the water (Figure 17). Never lift the cleaner out of the pool by the floating cable or swivel.

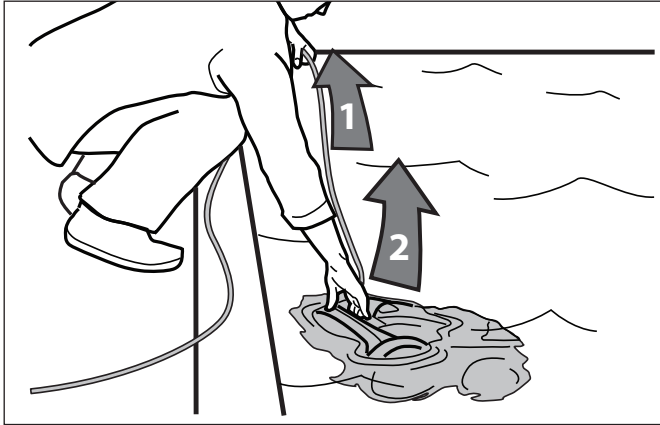

Figure 17. Remove Cleaner From Pool with Handle

2. Hold the cleaner vertically to drain (Figure 18).

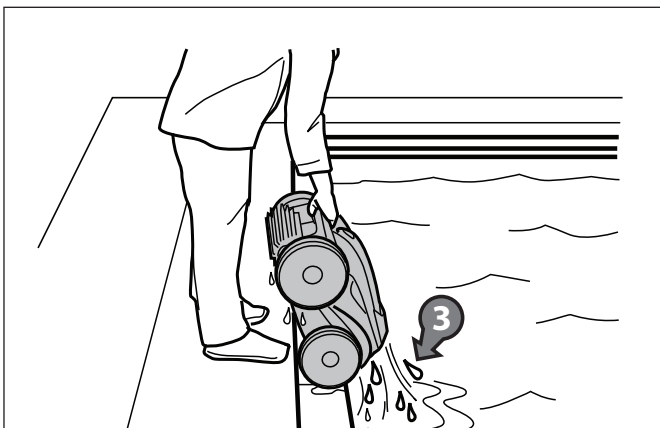

Figure 18. Keep Cleaner Vertical to Drain Water

3. Unplug power to the cleaner at the control unit (Figure 19).

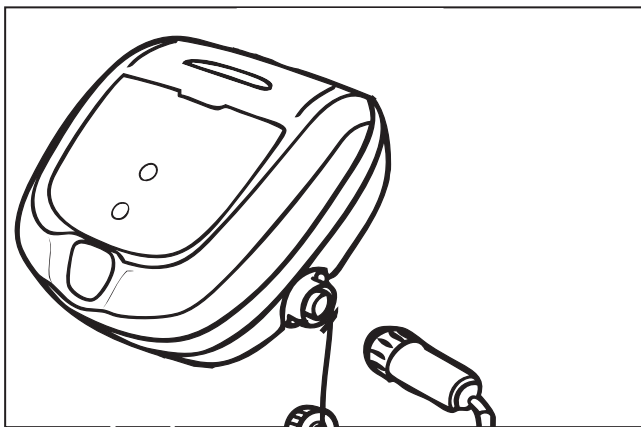

Figure 19. Unplug

4. Remove the cleaner from the pool and untangle all kinks and coils in the power cable (Figure 20). Start at the cleaner head. Lay the cable in the sun to loosen any tangling memory.

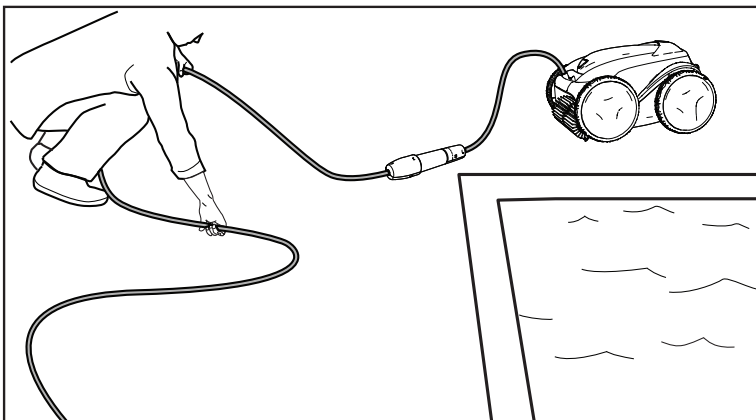

Figure 20. Untangle

Clean the Filter Canister

The filter canister should be cleaned at the end of each cycle.

1. Remove the cleaner from the water using the Lift System and let the remaining water drain.
2. Set the unit on four wheels.
3. Push the cover lock (1) and lift the cover (2) until it is secured in the vertical position. (Figure 21).

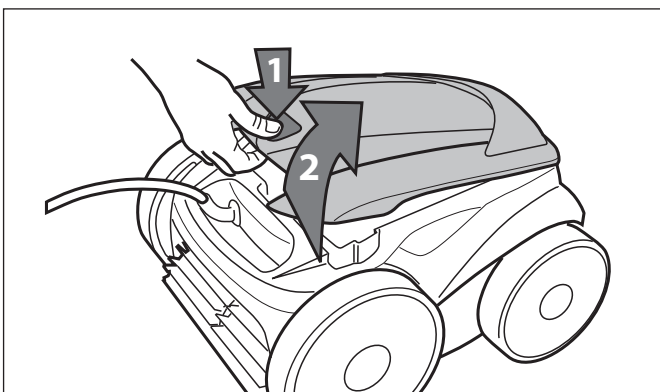

Figure 21. Lift Cleaner Cover

4. Remove the filter canister assembly from the body (3), as shown in Figure 22.

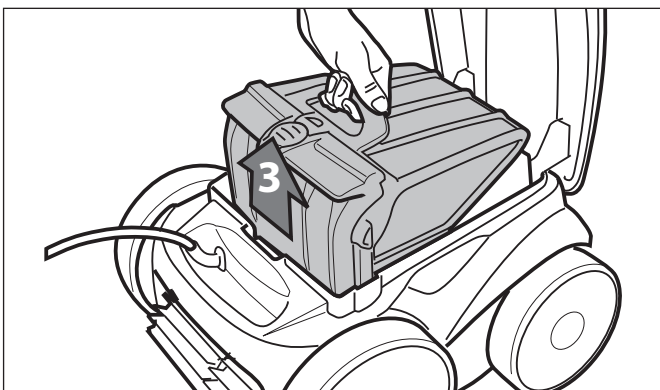

Figure 22. Remove Filter Canister Assembly

5. Push the quick release button on the canister assembly (4) and pull open Figure 23.

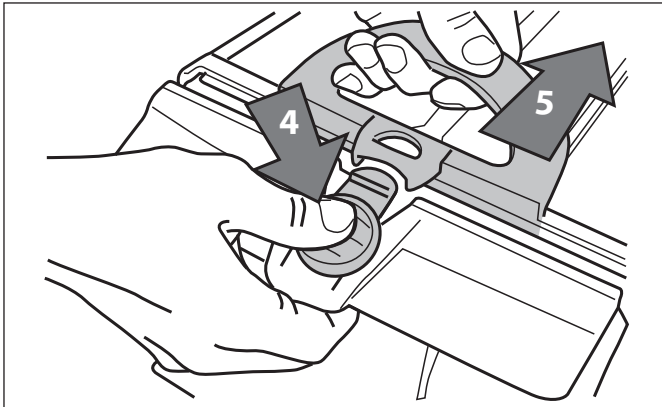

Figure 23. Open Filter Canister Assembly

6. Separate the filter canister from the filter support (6), as shown in Figure 24.

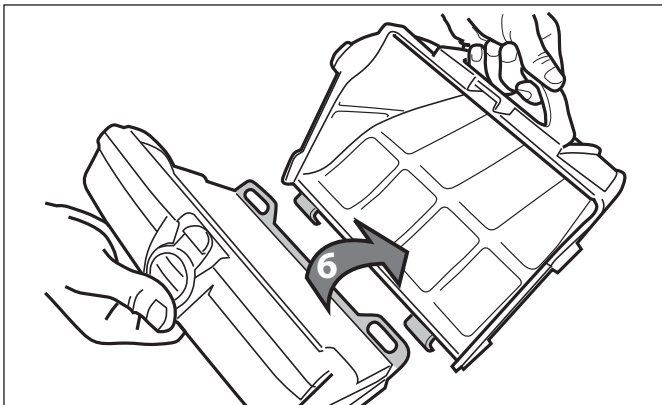

Figure 24. Remove Filter Canister

7. Empty all debris from the filter canister, then rinse the canister, the filter support and the cleaner using a hose, as shown in Figure 25.

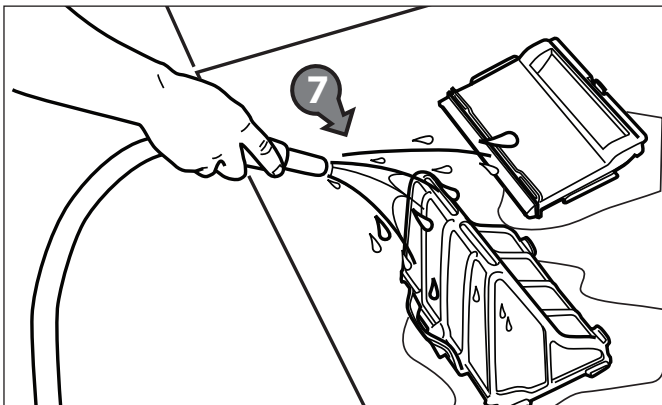

Figure 25. Wash Filter Canister

NOTE: Periodically, remove the filter canister and clean thoroughly with soapy water and a soft bristle brush.

Store the Cleaner When Not in Use

The cleaner must be cleaned regularly using slightly soapy clean water. Do not use solvents such as trichlorethylene or its equivalent. Rinse the cleaner generously using clean water. Do not let your cleaner dry in direct sunlight near the pool. The cleaner should be stored on its caddy so that it dries quickly.

1. Disconnect cleaner from the power source.
2. Starting at the cleaner head, remove all coils and tangles from the cable (Figure 26). Lay the cable in the sun to loosen any tangling memory.
3. Place the rear wheels on the caddy and position the cleaner vertically on the caddy base.
4. Disconnect the cable from the control unit. Replace the protective cap on the control unit.

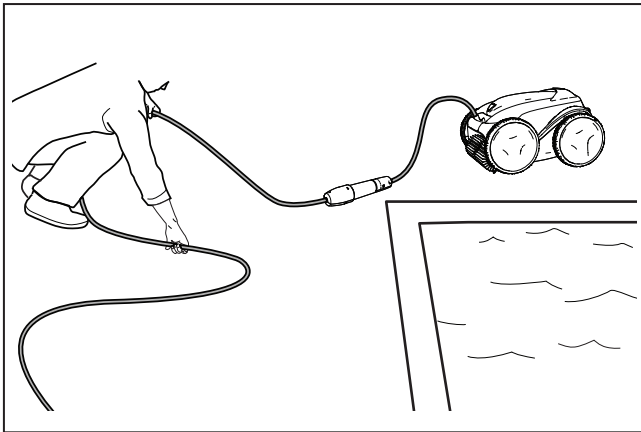

Figure 26. Untangle the Floating cable

5. Loosely coil the floating cable starting at the cleaner and moving toward the connection point at control unit. Store the cable by wrapping it around the hook located on the front of the caddy.

Replacing Wear Parts

Replacing Brushes

The cleaner is fitted with PVC brushes with a "wear" indicator. (Figure 27).

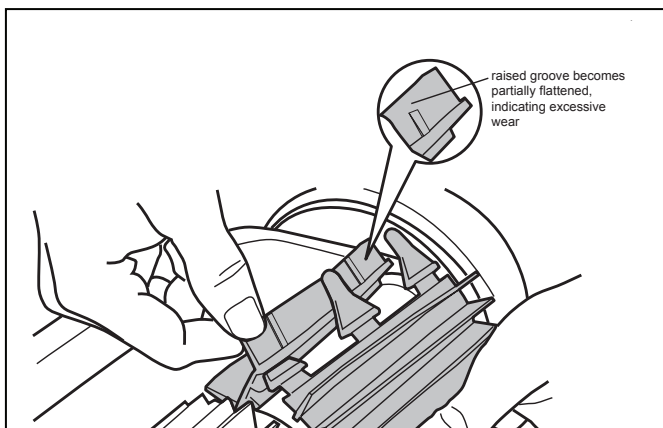

Figure 27. Worn Brush Indicator

To maintain cleaner performance at its best you need to replace the brushes as soon as one of the wear indicators is reached (even if the blade wear is not even). It is recommended that you replace the brushes when the rubber is worn down to the top of the wear indicator (or every two years, whichever comes first).

To replace a worn brush:

1. Lift the cleaner to a vertical position so that the handle is up (Figure 28).

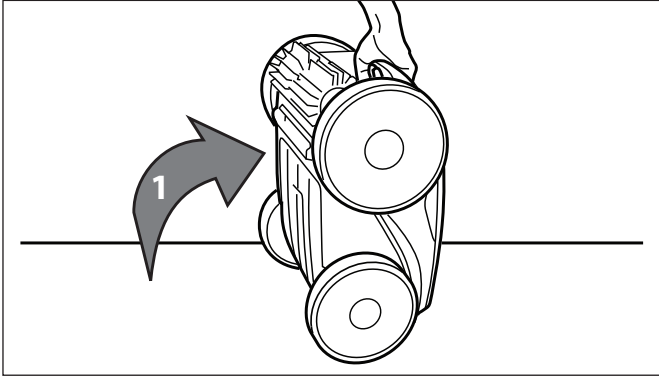

Figure 28. Cleaner in Upright Position

2. Separate the edges of the brush and undo the tabs (Figure 29). Remove the worn brushes.

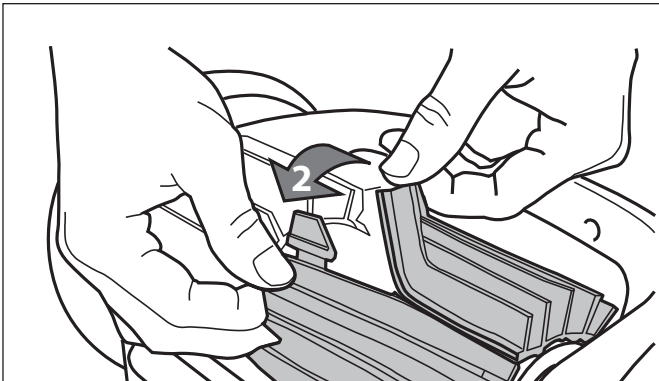

Figure 29. Undo the Tabs of the Brush

3. To install the new brush, position the new brush on the roller with the cleaning blades facing away from the roller (Figure 30).

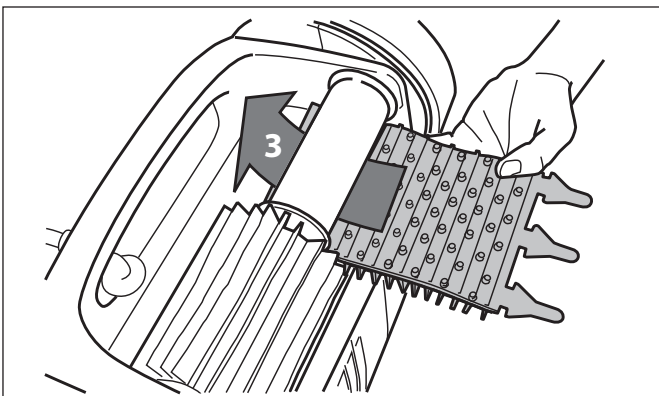

Figure 30. Install the New Brush

4. Thread each tab into the slot provided and gently feed it through until the heel comes out at the other side of the slot (Figure 31).

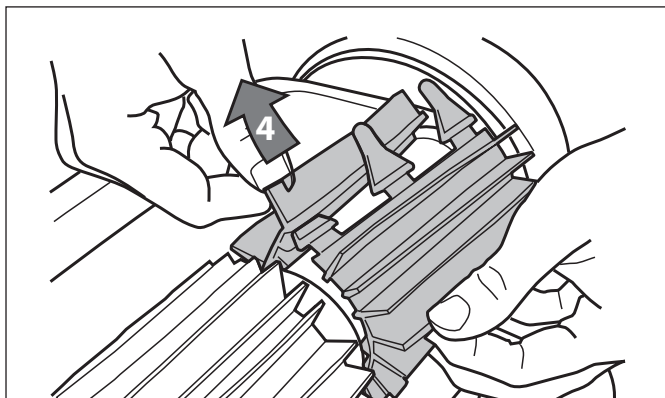

Figure 31. Pull Tabs Through Each Slot

5. Use a pair of scissors to cut the tabs 20mm from the heel so that they are no higher than the cleaning blade (Figure 32).
6. Repeat the procedure to install the second brush

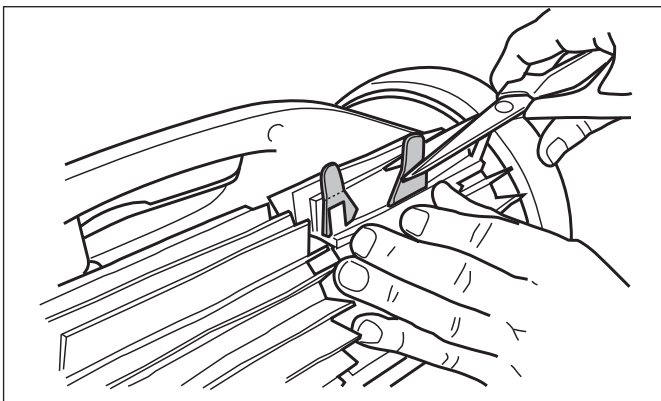

Figure 32. Cut Tabs

Replacing Tyres

1. Pull on the inside of the old tyre to remove the tyre lip from the wheel (Figure 33).

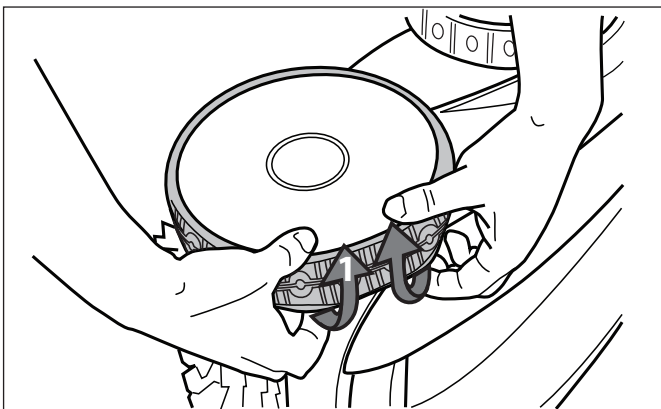

Figure 33. Pull the Old Tyre Over the Wheel

2. Remove the old tyre (Figure 34).

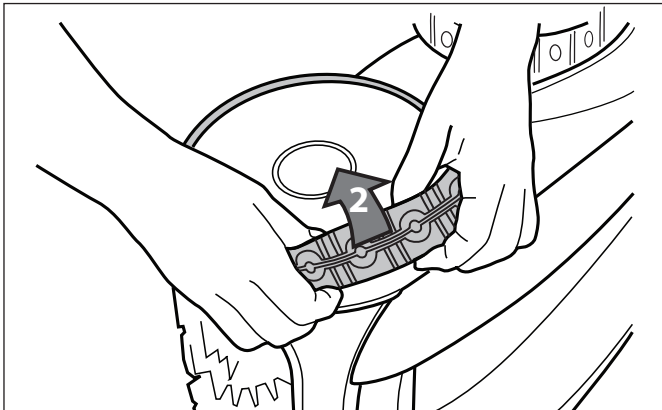

Figure 34. Remove the Old Tyre

3. To replace the tyre, position the tyre on the wheel making sure to orient the tyre so that the word **INSIDE** is toward the body of the cleaner (Figure 35).

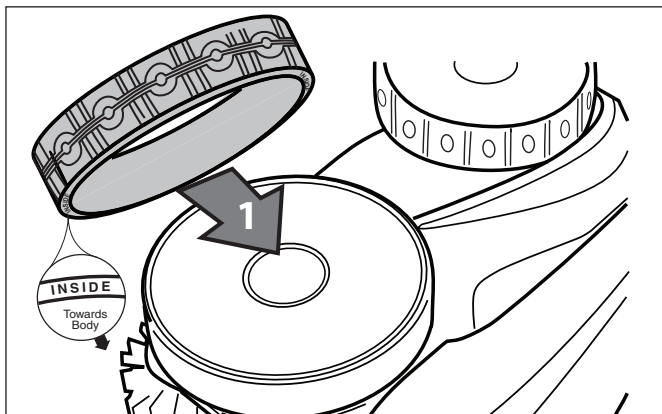

Figure 35. Tyre Replacement Orientation

4. Push one side of the tyre on to the wheel and fit the rib of the tyre in the groove of the wheel (Figure 36).

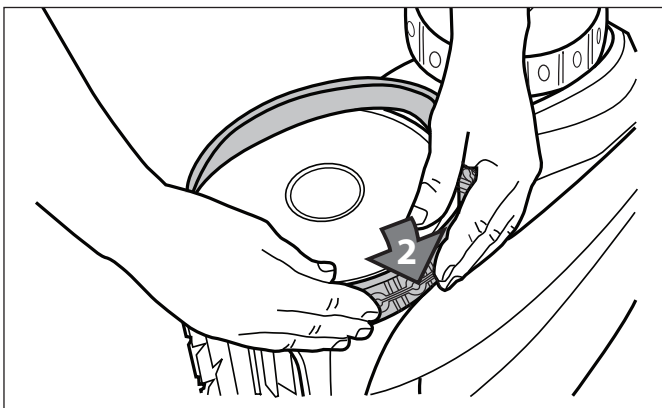

Figure 36. Start on One Side of the Tyre

5. Work the tyre onto the wheel and verify the rib of the tyre is positioned properly within the groove of the wheel (Figure 37).

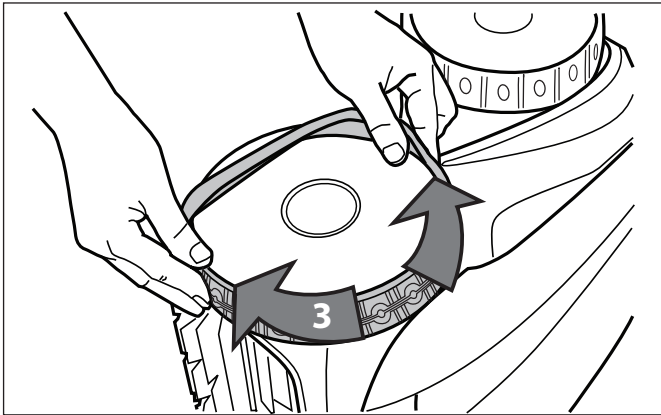

Figure 37. Work the Tyre On Around the Wheel

6. Push and position the rib of the inner side of the tyre in the groove of the wheel (Figure 38). If needed, turn the wheel gently to help with installation.

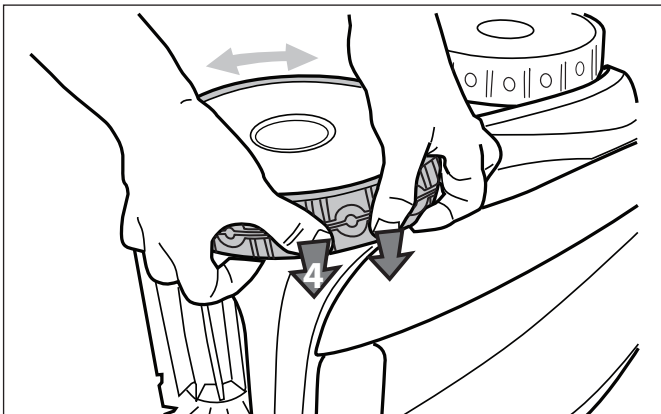

Figure 38. Push the Tyre into Place on the Wheel

8 Troubleshooting

Information about the cleaner status and any relevant condition will be displayed on the control unit and/or in the iAquaLink™ app.

Error Codes

Control Unit Display	In-App Display	Suggested Solution
1	Pump Motor	a. Check for corrosion or bent pins in the floating cable connection area.
2	Traction Motor Right	b. Turn each wheel one quarter turn in one direction repeatedly until rotation is smooth. Repeat, turning wheels in the opposite direction until rotation is smooth.
3	Traction Motor Left	c. If this does not resolve the problem, contact your local retailer for a diagnostic review or call customer service.
4	Pump Motor Consumption	a. Check for small debris or hair in the fan impeller. b. Thoroughly clean the filter canister. c. If this does not resolve the problem, contact your local retailer for a diagnostic review or call customer service.
5	Drive Motor Consumption Right	a. Thoroughly clean the filter canister. b. Turn off the cleaner and submerge. Shake to release air bubbles. Restart cycle.
6	Drive Motor Consumption Left	c. If this does not resolve the problem, contact your local retailer for a diagnostic review or call customer service.
7	Cleaner Floating	• Turn cleaner power off, then submerge cleaner according to correct procedure.
8	Cleaner Out of the Water	• Turn off the cleaner and submerge. Shake to release air bubbles. Restart cycle.
9	N/A	• Cleaner has completed a cleaning cycle. This is not an error. No action required.
10	Communication	a. Turn cleaner power off and on again to reset. b. Check floating cable connection to the control unit. Check for corrosion or bent pins at the connection point. c. If this does not resolve the problem, contact your local retailer for a diagnostic review or call customer service.
N/A	Connection Error	a. Check that the control unit is plugged into an approved power outlet and that the LAN/WEB icons on the box are illuminated. b. If not, go through the set-up steps to reconnect to the home router or press the Wi-Fi to Phone button to connect the system in 15-minute Wi-Fi to Phone mode. c. Check that the router is in close enough range to the control unit. Install a Wi-Fi extender if necessary.

General Troubleshooting

The following list provides some helpful hints for troubleshooting common challenges when using the cleaner.

User Issue	Possible Cause	Suggested Solution
Lights on control unit flash after pressing Start/Stop	Floating cable not connected	Unplug and then reconnect the floating cable to the control unit.
	Cleaner not fully submerged.	Remove cleaner from pool and re-submerge. (see: <i>Install and Submerge the Cleaner</i>).
	Poor connection or need to restart cycle.	Unplug the control unit and reconnect to an approved power outlet. Press "Start" to begin a new cycle.
	Propeller or wheels may be jammed and not turning correctly.	Contact your local retailer to request a diagnostic review. If the problem is not resolved, contact Zodiac Customer Care at 1300 763 021.
The flashing lights appear on the control unit during the cleaning cycle.	Cleaner not fully submerged	Remove cleaner from pool and re-submerge. (see: <i>Install and Submerge the Cleaner</i>).
The cleaner does not stay on the pool surface or is floating excessively.	There is air trapped inside the cleaner housing.	Remove cleaner from pool and re-submerge. (see: <i>Install and Submerge the Cleaner</i>).
	The filter canister is full or dirty.	Dispose of debris and thoroughly clean the filter canister with mild soap and a soft brush. Then, re-submerge the cleaner (see: <i>Clean the Filter Canister</i>).
The cleaner is not climbing walls.	The filter canister is full or dirty.	Dispose of debris and thoroughly clean the filter canister with mild soap and a soft brush. Then, re-submerge the cleaner (see: <i>Clean the Filter Canister</i>).
	Tyre treads worn down	See: <i>Replacing Wear Parts</i>
	Confirm appropriate pool chemistry	Speak with your pool service professional. Do not leave cleaner in the pool during any chemical treatments.
The cleaner is not moving	Not connected to electricity.	The outlet the control unit is connected to, is not supplying electrical power. Check that the outlet to which the control unit is connected is receiving electricity.
	Cycle not started.	Press the Start button to initiate a cleaning cycle.
	Reset needed	Disconnect the unit power and reconnect after 20 seconds. If the problem is not resolved, contact your local retailer to request a diagnostic review or contact Zodiac Customer Care at 1300 763 021.

The floating cable has excessive tangling	Too much cable in the water.	Place only the required amount of cable into the water to allow it to reach the farthest end of your pool with remaining cable on the pool deck. (See: <i>Install and Submerge the Cleaner</i>)
	Removal needed	Untangle the twisted cord and lay in sun to reduce memory. (See: <i>Cord Tangling</i>).
User Issue	Possible Cause	Suggested Solution
The cleaner is not cleaning the pool effectively.	Filter canister is full or dirty.	Dispose of debris and thoroughly clean the filter canister with mild soap and a soft brush. Then, re-submerge the cleaner (see: <i>Clean the Filter Canister</i>).
	Brushes are worn.	Check the wear indicator(s). Contact your local dealer for spare parts.
	Cable is excessively tangled.	Untangle the twisted cord and lay in sun to reduce memory. (See: <i>Cord Tangling</i>).

Dismissing an Error Code

From the Control Unit:

After you have completed the troubleshooting solution steps, press any key (except the phone icon) to clear the error code.

If the control unit is in Standby Mode, press the Start/Stop button to show the on-screen display. After you have completed the troubleshooting solution steps, press any key (except the phone icon) to clear the error code.

From the iAquaLink™ App:

Press the error icon to display troubleshooting solutions. After you have completed the troubleshooting solution steps, press **Clear Error** to return to normal operation. Or, press **OK** if you need to complete the solution steps at a later time.

iAquaLink™ Troubleshooting

This information can help to troubleshoot connection and setup challenges between the iAquaLink app and the cleaner.

How It Works

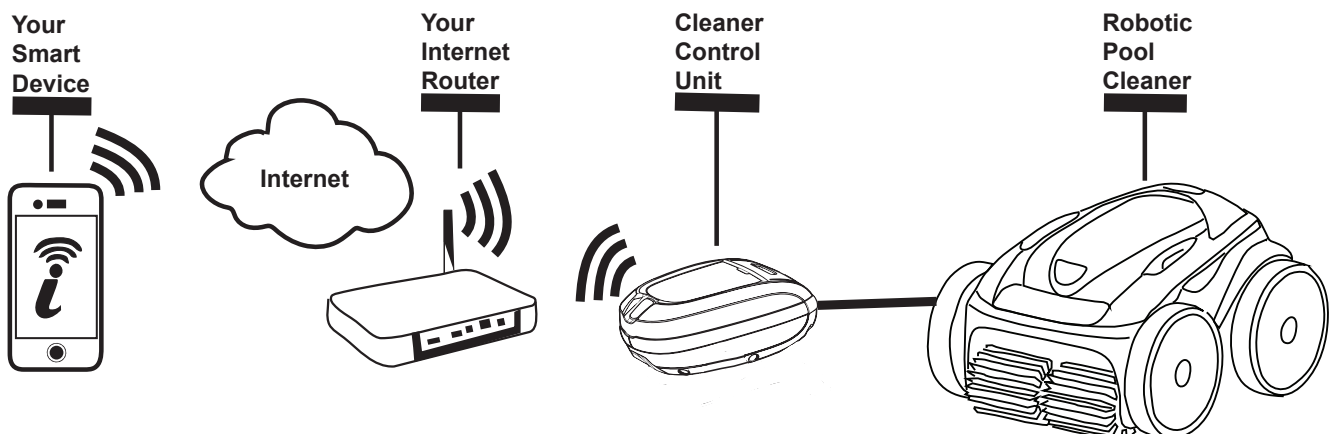

How to connect:

You must connect to the home router (network) by first establishing a direct connection between the control box and your smart device. (See: *Configuring the System.*)

IMPORTANT: It is recommended to locate the control box as close to the home router as practical. Do not use an extension cord.

Common iAquaLink™ Troubleshooting

Remember, if you get a new Wi-Fi Router, reset the defaults of your current Wi-Fi Router or simply change your Wi-Fi network password, you will have to re-establish the connection between your cleaner and the router. (See: *Configure the System.*)

User Issue	Possible Cause	Suggested Solution
All lights are off	Bright sunlight	Shield the lights to block sunlight and re-check if the lights are lit.
	Control box is unplugged.	Plug the control box into a power outlet. (See: <i>Connect to a Power Source.</i>)
	Power outage.	Verify that the breaker is on and electricity is being supplied to the outlet.
	Lost internet connection.	Check internet connection - Network may be down.
LAN/WEB lights are not on	Lost internet connection	Check internet connection - Network may be down.
LAN/WEB lights are on but there is no (or spotty) Wi-Fi connection, and/or app reads "Connection Error"	Control box is too far from home router	Relocate the control box as near to the home router as practical. (See: <i>Install and Submerge the Cleaner</i>) Do not use an extension cord.
	Weak Wi-Fi signal	<ul style="list-style-type: none"> Check for adequate Wi-Fi signal strength. With a Windows laptop, go to Network Connections in the Control Panel. Check Signal Strength meter under Wireless Network Connection icon while standing near the control box. With a smart device, search for, download, and use an app that can check signal strength while standing near the control box. If Wi-Fi signal is weak, consider installing a Wi-Fi extender.
Only one of the LAN/WEB lights are on	Connectivity issue with local Wi-Fi or connection to the server.	Contact your local internet service provider. <ul style="list-style-type: none"> Unplug your control box and wait 10 seconds. Plug in the box again and see if lights illuminate. Check Internet connection - Network may be down.
LAN/WEB lights are flashing	Antenna firmware update in progress.	Flashing may continue up to ten minutes until update is complete.

Conformity



The manufacturer reserves the right to modify these specifications without notice. Although the cleaning robots have been tested in a large variety of swimming pools, Zodiac cannot be held responsible in the case of a non-perfect adaptation of the robot to a particular swimming pool.

Zodiac Group Australia Pty Ltd.
PO Box 7238
Wetherill Park NSW 2164, Australia
1300 763 021 | www.zodiac.com.au

ZODIAC® is a registered trademark of Zodiac International, S.A.S.U., used under license. All trademarks referenced herein are the property of their respective owners.

©2017 Zodiac Pool Systems, Inc. H0615700 REV A

