



Installation Manual

ePump™ Variable Speed Pump ePump Controller



WARNING

FOR YOUR SAFETY - This product must be installed and serviced by a contractor who is licensed and qualified in pool equipment by the jurisdiction in which the product will be installed where such state or local requirements exist. In the event no such state or local requirement exists, the maintainer must be a professional with sufficient experience in pool equipment installation and maintenance so that all of the instructions in this manual can be followed exactly. Before installing this product, read and follow all warning notices and instructions that accompany this product. Failure to follow warning notices and instructions may result in property damage, personal injury, or death. Improper installation and/or operation will void the warranty.

Improper installation and/or operation can create unwanted electrical hazard which can cause serious injury, property damage, or death.

Table of Contents

<p>Section 1. Important Safety Instructions 4</p> <p>1.1 Safety Instructions 4</p> <p>1.2 Pool Pump Suction Entrapment Prevention Guidelines 7</p> <p>Section 2. Installation of the ePump Controller 9</p> <p>2.1 Introduction 9</p> <p>2.2 The Controller Panel 9</p> <p>2.3 The Controller Components 9</p> <p>2.4 Installation of the Backplate onto an Electrical Box 9</p> <p>2.5 Installation of the Backplate on a Flat Wall 10</p> <p>2.6 Connection to the Jandy ePump Variable Speed Pump 10</p> <p>2.7 Jandy ePump Variable Speed Pump Switch Settings 10</p> <p>2.8 Connection to Remote Contacts 11</p> <p>2.9 Remote Operation 11</p> <p>2.10 Remote Closure 4 Behavior 11</p> <p>Section 3. User Operation 12</p> <p>3.1 OFF Mode 12</p> <p>3.2 RUN Mode 12</p> <p>3.3 Manual Start and Stop 12</p> <p>3.4 Pump Speed Setting 12</p> <p>3.5 Timeclock Setup and Operation 13</p> <p>Section 4. Service Setup Options 14</p> <p>4.1 Entering Service Setup 14</p> <p>4.2 Minimum and Maximum Pump Speeds 14</p> <p>4.3 Load Defaults 14</p> <p>4.4 Last Fault 14</p> <p>4.5 Priming Speed and Duration 15</p>	<p>4.6 eStar Speed 15</p> <p>4.7 Pump Freeze Protect Operation 15</p> <p>4.8 Selecting Pump Type 16</p> <p>4.9 Display Power Usage 16</p> <p>Section 5. User Set Up Options 16</p> <p>5.1 Setting Time-of-Day 16</p> <p>5.2 Labeling Presets 17</p> <p>5.3 General Labels 17</p> <p>5.4 Custom Labels 17</p> <p>5.5 Display Light Control 17</p> <p>5.6 Language Selection 18</p> <p>5.7 Run Duration (Presets 3 and 4 Only) 18</p> <p>5.8 Scale 18</p> <p>Section 6. Menu Flow Chart 19</p>
--	--

EQUIPMENT INFORMATION RECORD

DATE OF INSTALLATION _____

INSTALLER INFORMATION _____

INITIAL PRESSURE GAUGE READING (WITH CLEAN FILTER) _____

PUMP MODEL _____ **HORSEPOWER** _____

FILTER MODEL _____ **SERIAL NUMBER** _____

CONTROLLER MODEL _____ **SERIAL NUMBER** _____

NOTES: _____

Section 1. Important Safety Instructions

READ AND FOLLOW ALL INSTRUCTIONS

LIRE LA NOTICE TECHNIQUE.

1.1 Safety Instructions

All electrical work must be performed by a licensed electrician and conform to all national, state, and local codes. When installing and using this electrical equipment, basic safety precautions should always be followed, including the following:

WARNING

RISK OF SUCTION ENTRAPMENT HAZARD, WHICH, IF NOT AVOIDED, CAN RESULT IN SERIOUS INJURY OR DEATH. Do not block pump suction, as this can cause severe injury or death. Do not use this pump for wading pools, shallow pools, or spas containing bottom drains, unless the pump is connected to at least two (2) functioning suction outlets. Drain covers must be certified to the latest published edition of ANSI/ASME A112.19.8.

WARNING

To reduce the risk of injury, do not permit children to use this product.

WARNING

To reduce the risk of property damage or injury, do not attempt to change the backwash (multiport, slide, or full flow) valve position with the pump running.

DANGER

To reduce the risk of injury, do not remove the suction fittings of your spa or hot tub. Never operate a spa or hot tub if the suction fittings are broken or missing. Never replace a suction fitting with one rated less than the flow rate marked on the equipment assembly.

WARNING

Prolonged immersion in hot water may induce hyperthermia. Hyperthermia occurs when the internal temperature of the body reaches a level several degrees above the normal body temperature of 98.6°F (37°C). The symptoms of hyperthermia include dizziness, fainting, drowsiness, lethargy, and an increase in the internal temperature of the body. The effects of hyperthermia include: 1) unawareness of impending danger; 2) failure to perceive heat; 3) failure to recognize the need to exit spa; 4) physical inability to exit spa; 5) fetal damage in pregnant women; 6) unconsciousness resulting in a danger of drowning.

WARNING

To Reduce the Risk of Injury -

- a) The water in a spa should never exceed 104°F (40°C). Water temperatures between 100°F (38°C) and 104°F (40°C) are considered safe for a healthy adult. Lower water temperatures are recommended for young children and when spa use exceeds 10 minutes.
- b) Since excessive water temperatures have a high potential for causing fetal damage during the early months of pregnancy, pregnant or possibly pregnant women should limit spa water temperatures to 100°F (38°C).
- c) Before entering a spa or hot tub, the user should measure the water temperature with an accurate thermometer since the tolerance of water temperature-regulating devices varies.
- d) The use of alcohol, drugs, or medication before or during spa or hot tub use may lead to unconsciousness with the possibility of drowning.
- e) Obese persons and persons with a history of heart disease, low or high blood pressure, circulatory system problems, or diabetes should consult a physician before using a spa.
- f) Persons using medication should consult a physician before using a spa or hot tub since some medication may induce drowsiness while other medication may affect heart rate, blood pressure, and circulation.

⚠ WARNING

To minimize risk of severe injury or death, the filter and/or pump should not be subjected to the piping system pressurization test.

Local codes may require the pool piping system to be subjected to a pressure test. These requirements are generally not intended to apply to the pool equipment, such as filters or pumps.

Jandy pool equipment is pressure tested at the factory.

If, however, the WARNING cannot be followed and pressure testing of the piping system must include the filter and/or pump, **BE SURE TO COMPLY WITH THE FOLLOWING SAFETY INSTRUCTIONS:**

- Check all clamps, bolts, lids, lock rings, and system accessories to ensure they are properly installed and secured before testing.
- **RELEASE ALL AIR** in the system before testing.
- Water pressure for test must **NOT EXCEED 35 PSI**.
- Water temperature for test must **NOT EXCEED 100°F (38°C)**.
- Limit test to 24 hours. After test, visually check system to be sure it is ready for operation.

Notice: These parameters apply to Jandy equipment only. For non-Jandy equipment, consult the equipment manufacturer.

⚠ WARNING

Due to the potential risk of fire, electric shock, or injuries to persons, Jandy Pumps must be installed in accordance with the National Electrical Code (NEC), all local electrical and safety codes, and the Occupational Safety and Health Act (OSHA). Copies of the NEC may be ordered from the National Fire Protection Association, 470 Atlantic Ave., Boston, MA 02210, or from your local government inspection agency.

⚠ WARNING

Incorrectly installed equipment may fail, causing severe injury or property damage.

⚠ WARNING

- Do not connect system to an unregulated city water system or other external source of pressurized water producing pressures greater than 35 PSI.
- Trapped air in the system can cause the filter lid to be blown off, which can result in death, serious personal injury, or property damage. Be sure all air is out of the system before operating.

CAUTION

Do not start pump dry! Running the pump dry for any length of time will cause severe damage and will void the warranty.

⚠ WARNING

People with infectious diseases should not use a spa or hot tub.

To avoid injury, exercise care when entering or exiting the spa or hot tub.

Do not use drugs or alcohol before or during the use of a spa or hot tub to avoid unconsciousness and possible drowning.

Pregnant or possibly pregnant women should consult a physician before using a spa or hot tub.

Water temperature in excess of 100°F (38°C) may be injurious to your health.

Before entering a spa or hot tub measure the water temperature with an accurate thermometer.

Do not use a spa or hot tub immediately following strenuous exercise.

Prolonged immersion in a spa or hot tub may be injurious to your health.

Do not permit any electric appliance (such as a light, telephone, radio, or television) within five 5 feet (1.5m) of a spa or hot tub.

The use of alcohol, drugs or medication can greatly increase the risk of fatal hyperthermia in hot tubs and spas.

Water temperature in excess of 100°F (38°C) may be hazardous to your health.

⚠ AVERTISSEMENT

Les personnes atteintes de maladies infectieuses ne devraient pas utiliser une cuve de relaxation.

Pour éviter des blessures, user de prudence en entrant dans une cuve de relaxation et en sortant.

Pour éviter l'évanouissement et la noyade éventuelle, ne prendre ni drogue ni alcool avant d'utiliser une cuve de relaxation ni quand on s'y trouve.

Les femmes enceintes, que leur grossesse soit confirmée ou non, devraient consulter un médecin avant d'utiliser une cuve de relaxation.

Il peut être dangereux pour la santé de se plonger dans de l'eau à plus de 38°C (100°F).

Avant d'utiliser une cuve de relaxation mesurer la température de l'eau à l'aide d'un thermomètre précis.

Ne pas utiliser une cuve de relaxation immédiatement après un exercice fatigant.

L'utilisation prolongée d'une cuve de relaxation peut être dangereuse pour la santé.

Ne pas placer d'appareil électrique (luminaire, téléphone, radio, téléviseur, etc) à moins de 1.5m de cette cuve de relaxation.

La consommation d'alcool ou de drogue augmente considérablement les risques d'hyperthermie mortelle dans une cuve de relaxation.

Il peut être dangereux pour la santé de se plonger dans de l'eau à plus de 38°C (100°F).

⚠ WARNING

To avoid injury ensure that you use this control system to control only packaged pool/spa heaters which have built-in operating and high limit controls to limit water temperature for pool/spa applications. This device should not be relied upon as a safety limit control.



Attention installer: Install to provide drainage of compartment for electrical components.

SAVE THESE INSTRUCTIONS

1.2 Pool Pump Suction Entrapment Prevention Guidelines

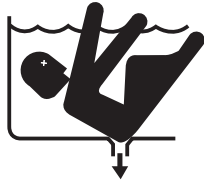

⚠ WARNING

SUCTION HAZARD. Can cause serious injury or death. Do not use this pump for wading pools, shallow pools, or spas containing bottom drains, unless pump is connected to at least two (2) functioning suction outlets.

⚠ WARNING

Pump suction is hazardous and can trap and drown or disembowel bathers. Do not use or operate swimming pools, spas, or hot tubs if a suction outlet cover is missing, broken, or loose. The following guidelines provide information for pump installation that minimizes risk of injury to users of pools, spas, and hot tubs:

Entrapment Protection - The pump suction system must provide protection against the hazards of suction entrapment.

Suction Outlet Covers - All suction outlets must have correctly installed, screw-fastened covers in place. All suction outlet (drain) covers must be maintained. Drain covers must be listed/certified to the latest published edition of ANSI/ASME A112.19.8. They must be replaced if cracked, broken, or missing.

Number of Suction Outlets Per Pump - Provide at least two (2) hydraulically-balanced main drains, with covers, as suction outlets for each circulating pump suction line. The centers of the main drains (suction outlets) on any one (1) suction line must be at least three (3) feet apart, center to center. See Figure 1.

The system **must** be built to include at least two (2) suction outlets (drains) connected to the pump whenever the pump is running. However, if two (2) main drains run into a single suction line, the single suction line may be equipped with a valve that will shut off both main drains from the pump. The system shall be constructed such that it shall not allow for separate or independent shutoff or isolation of each drain. See Figure 1.

More than one (1) pump can be connected to a single suction line as long as the requirements above are met.

Water Velocity - The maximum water velocity through the suction fitting or cover for any suction outlet must be 1.5 feet per second, unless the outlet complies with the latest published edition of ANSI/ASME A112.19.8, the standard for *Suction Fittings For Use in Swimming and Wading Pools, Spas, Hot Tubs, and Whirlpool Bathtub Applications*. In any case, do not exceed the suction fitting's maximum designed flow rate.

If 100% of the pump's flow comes from the main drain system, the maximum water velocity in the pump suction hydraulic system must be six (6) feet per second or less, even if one (1) main drain (suction outlet) is completely blocked. The flow through the remaining main drain(s) must comply with the latest published edition of ANSI/ASME A112.19.8, the standard for *Suction Fittings For Use in Swimming and Wading Pools, Spas, Hot Tubs, and Whirlpool Bathtub Applications*.

Testing and Certification - Suction outlet covers must have been tested by a nationally recognized testing laboratory and found to comply with the latest published edition of ANSI/ASME A112.19.8, the standard for *Suction Fittings For Use in Swimming and Wading Pools, Spas, Hot Tubs, and Whirlpool Bathtub Applications*.

Fittings - Fittings restrict flow; for best efficiency use fewest possible fittings (but at least two (2) suction outlets).

Avoid fittings that could cause an air trap.

Pool cleaner suction fittings must conform to applicable International Association of Plumbing and Mechanical Officials (IAPMO) standards.

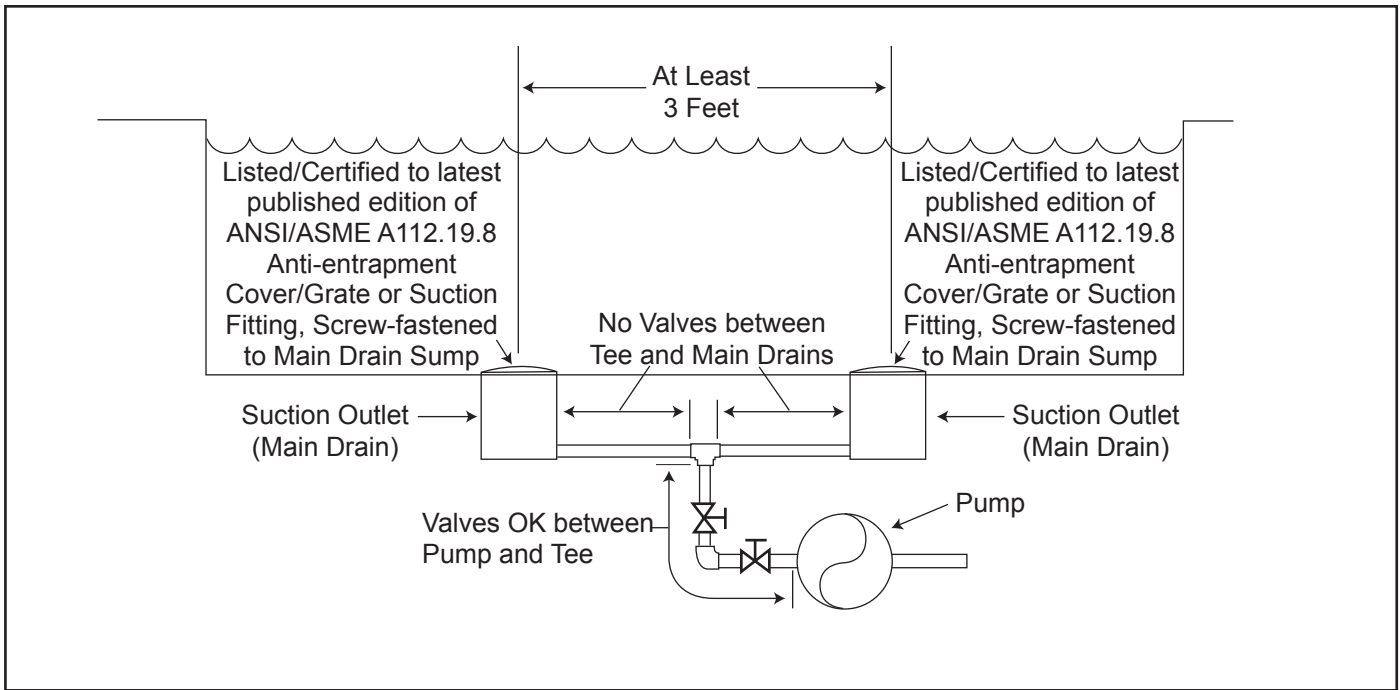

Figure 1. Number of Suction Outlets Per Pump

Section 2. Installation of the ePump Controller

2.1 Introduction

This document provides general instructions to install the controller for use with the Jandy ePump variable speed pump. The controller can be mounted to an electrical gang box (single, double, or triple) or to a flat wall.

The instructions have been written with safety as the priority, and must be followed exactly. Read through the instructions completely before starting the procedure.

Please note, the ePump Controller can not be used in conjunction with a Jandy PDA or OneTouch™ Controller.

2.2 The Controller Panel

The controller panel provides both timed and manual speed controls for the Jandy ePump Variable Speed Pump.

Four

speed presets are directly available on the panel, while four (4) additional presets may be accessed via the **MENU** key.

The up and down keys are used to adjust the pump speed. The speed is saved as it is adjusted. No further action is required to save the new speed setting after adjustment. The selected speed can be saved and assigned to one of the speed buttons.

As shown in Figure 1, preset speed "★" is assigned to the "eStar" feature. Hence, it is intended to be assigned an energy-efficient filtration speed, as determined by the installer.

2.3 The Controller Components

The ePump controller assembly (See Figure 3) contains the following components:

1. ePump Controller
2. Mounting Gasket
3. Backplate
4. Round Seal
5. Six (6) Screws
6. Plastic Film

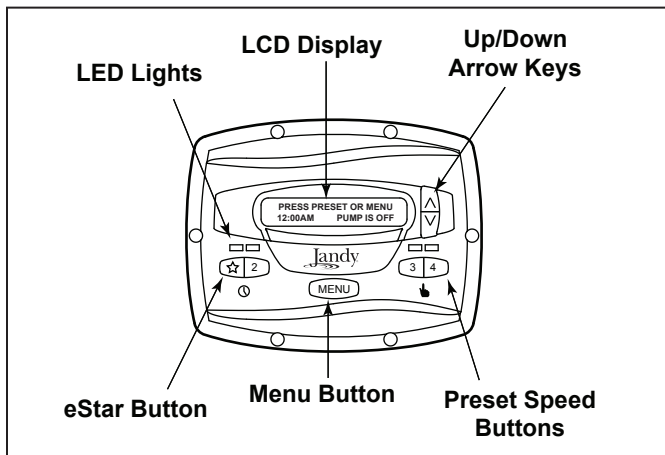

Figure 2. Jandy ePump Variable Speed Pump Controller Panel

Additional materials are required for the installation of the controller and must be supplied by the installer:

1. A cable to connect the pump to the remotely mounted controller, minimum size of 22 AWG (Jandy part number 4278). This cable will need to have four (4) conductors and be able to handle 24V control signals. This cable should be rated for the particular installation (for example: outdoor, UV resistant, direct burial, etc.) and should conform to all applicable codes and regulations. (A suitable cable is included in the JEP Series ePump water pumps.)
2. A minimum of two (2) fasteners to mount the controller back plate to a wall or electrical box. The fasteners should be suitable for the surface where the controller is to be remotely mounted.
3. A high-voltage disconnect switch, as required by the National Electric Code (NEC), within line of sight of the pump.

2.4 Installation of the Backplate onto an Electrical Box

⚠ CAUTION

Do not expose the user interface to direct sunlight. Too much direct sunlight will darken the LCD screen, and it will no longer be readable.

1. Turn off the pump at the control panel.
2. Turn off all electrical power to the pump at the main junction box or at the circuit breaker providing electrical power to the pump.

⚠ WARNING

ELECTRICAL SHOCK HAZARD

Turn off all switches and the main breaker in the ePump electrical circuit before starting the procedure. Failure to comply may cause a shock hazard resulting in severe personal injury or death.

3. Drill out the plastic film covering the backplate screw holes. See Figure 3.

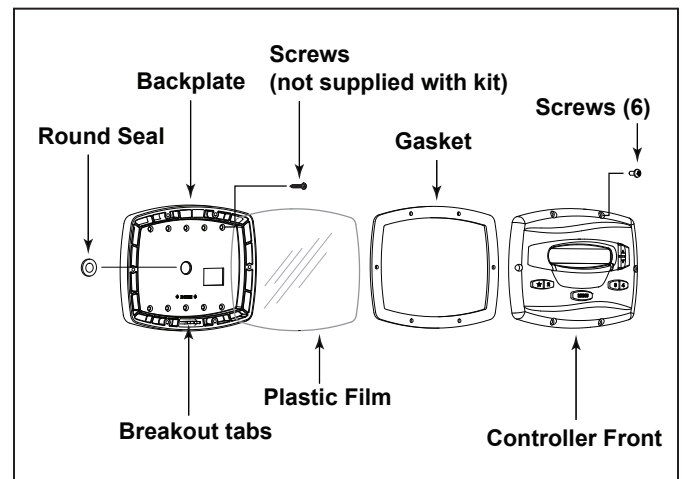

Figure 3. Controller Components

- Secure the backplate to the box using the screws that came with the electrical box.
- Drill out a 1/2" hole and insert the round seal supplied with the kit. A remote cable will run through the middle hole of the backplate and into the electrical box.

2.5 Installation of the Backplate on a Flat Wall

⚠ CAUTION

Do not expose the user interface to direct sunlight. Too much direct sunlight will darken the LCD screen, and it will no longer be readable.

- Turn off the pump at the control panel.
- Turn off all electrical power to the pump at the main junction box or at the circuit breaker providing electrical power to the pump.

⚠ WARNING

ELECTRICAL SHOCK HAZARD

Turn off all switches and the main breaker in the ePump electrical circuit before starting the procedure. Failure to comply may cause a shock hazard resulting in severe personal injury or death.

- A minimum of two (2) fasteners (installer supplied) are required when installing to a flat wall to hold the controller securely.
- The backplate has ten (10) mounting holes to choose from. Only drill out the plastic film from the holes to be used. See Figure 3.
- Mark the hole locations on the wall and use the fastener to secure the backplate to the wall.
- At the bottom of the backplate, cut the two (2) tabs out with an appropriate tool, such as a carton cutter or an exacto knife, and route the cable through the open channel.

2.6 Connection to the Jandy ePump Variable Speed Pump

The following steps provide the procedure for installing the controller to a Jandy ePump variable speed pump.

- Turn off all switches and the main breaker that supplies power to the pump.

⚠ WARNING

ELECTRICAL SHOCK HAZARD

Turn off all switches and the main breaker in the pump electrical circuit before starting the procedure. Failure to comply may cause a shock hazard resulting in severe personal injury or death.

- Remove the cover of the pump junction box.
- Feed the RS-485 cable into the fitting.

NOTE The controller uses a four-wire RS-485 interface to communicate with the ePump.

- Unplug the RS-485 connector from the pump.

- Attach the four (4) wires in the RS-485 cable to the RS-485 connector. Make sure the colors match the positions on the connector. See Figure 3.
- Connect the RS-485 connector back into the pump.
- Set the DIP switch settings for the pump controller with the 1 and 2 in the ON position and 3 and 4 in the OFF position. See Figure 4.
- Turn on all switches and the main breaker feeding power to the pump.
- Verify the operation of the controller. If the controller displays **FAULT PUMP NOT CONNECTED**, re-check the wiring and the DIP switch address setting on the pump.

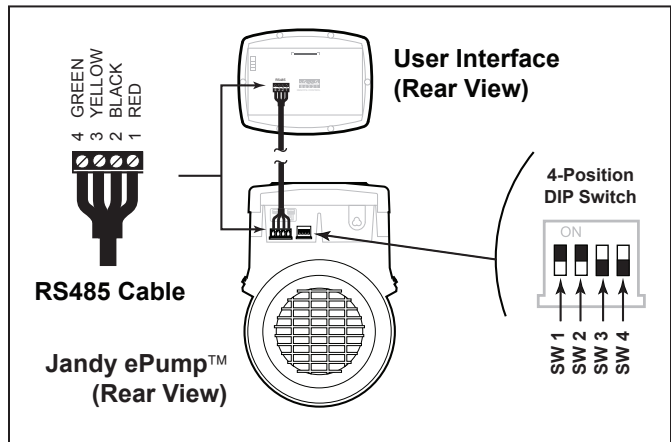

Figure 4. Wiring the User Interface to the Jandy ePump Variable Speed Pump

2.7 Jandy ePump Variable Speed Pump Switch Settings

For the ePump, the 4-position dip switch is located at the rear of the pump, as shown in Figure 3.

This dip switch serves two functions, it determines what type of control will be used with the pump and it selects the pump address. The SW 1 (switch 1) and SW 2 are turned ON if the pump is to be controlled by a stand alone controller or OFF if the pump is to be controlled by the AquaLink® RS or AquaLink® PDA.

SW 1	SW 2	CONTROL
OFF	OFF	AquaLink RS AquaLink PDA
ON	OFF	
OFF	ON	Stand Alone
ON	ON	

The SW 3 and SW 4 are turned ON/OFF to select the Pump address.

SW 3	SW 4	PUMP No.
OFF	OFF	1
ON	OFF	2
OFF	ON	3
ON	ON	4

2.8 Connection to Remote Contacts

The controller allows speeds "☆" through "4" to operate via remote contact closures (switch or relay). Speed "4" operates differently than the other three. See Section 2.10, Remote Closure 4 Behavior.

1. Turn off all switches and the main breaker that supplies power to the ePump.

⚠ WARNING

ELECTRICAL SHOCK HAZARD

Turn off all switches and the main breaker in the ePump electrical circuit before starting the procedure. Failure to comply may cause a shock hazard resulting in severe personal injury or death.

2. Connect one side of the remote contact closure to the COMMON terminal on J3 REMOTE CONTROL connector of the controller. See Figure 5.
3. Connect the other side of the remote contact closure to INPUT 1, INPUT 2, INPUT 3, or INPUT 4 terminal on J3 REMOTE CONTROL connector of the controller, depending on which speed is to be controlled.
4. Turn on all switches and the main breaker feeding power to the ePump.
5. Verify the operation of the contact closures. If the correct speed is activated when the closure is activated, the ePump starts, and the message **REMOTE ENABLED** appears on the controller display.

NOTE When starting the pump via a remote closure, the pump will first run at the priming speed for the priming duration, as set by the installer.

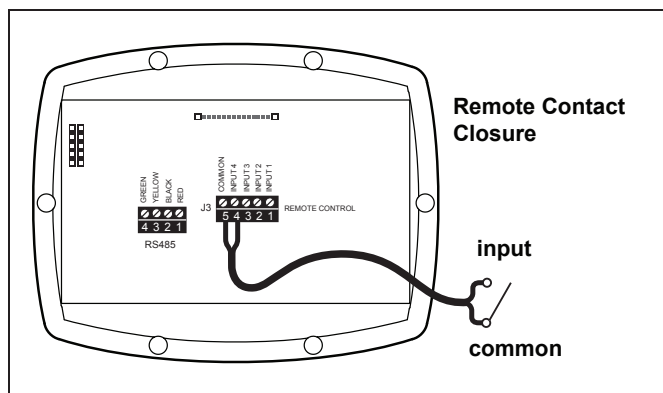
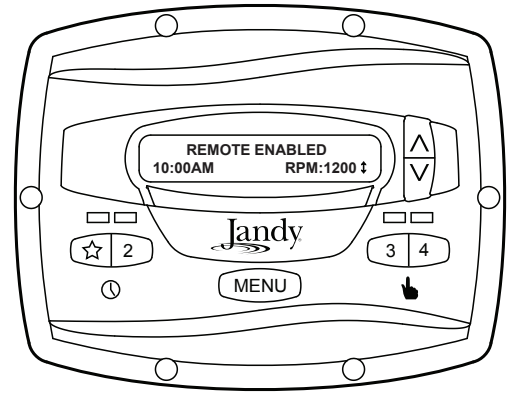

Figure 5. Connection to Remote Contacts

2.9 Remote Operation

Speeds activated via remote closures always override speeds that have been activated manually or via an internal timer program. When the pump is activated via a remote closure, the keypad is disabled and the message **REMOTE ENABLED** appears on the display.



The controller will remain in this state until the contact is opened. When more than one (1) contact closure occurs, the highest speed will take priority.

2.10 Remote Closure 4 Behavior

The behavior of speed "4" differs from manual operation when operated via a remote contact closure. As during manual operation, the turn-on time of remote closure 4 is immediate, and occurs at the same time as contact closure (For example, see Section 2.8). The turn-off time, however, is delayed by 30 minutes.

In other words, when remote closure 4 is de-activated, the ePump will continue to run for 30 minutes, after which time the controller will turn off the ePump. The delay may be manually interrupted by pressing any preset key.

2.10.1 Remote Closure 4 Application - Booster Pump Support

The behavior of remote closure 4 may be used to allow an external timeclock fitted with a 20-minute "fireman's switch" (e.g., Intermatic P/N 156T4042A) to properly control the ePump in conjunction with a booster pump.

Connection for Booster Pump Support:

1. Turn off all switches and the main breaker that supplies power to the ePump.

⚠ WARNING

ELECTRICAL SHOCK HAZARD

Turn off all switches and the main breaker in the ePump electrical circuit before starting the procedure. Failure to comply may cause a shock hazard resulting in severe personal injury or death.

2. Install the normally-closed fireman's switch to the timeclock assembly. (See timeclock manufacturer's instructions for details.)
3. Connect the main timeclock contacts to the booster pump power input per the booster pump installation manual.
4. Connect one side of the fireman's switch to the ePump Controller at J3 REMOTE CONTROL, COMMON.
5. Connect the other side of the fireman's switch to the ePump controller at J3 REMOTE CONTROL, INPUT 4.

6. Set the timeclock to the desired on/off times.
7. Turn on all switches and the main breaker feeding power to the ePump.
8. If the installation is working properly, the fireman's switch will open 20 minutes before the booster pump shuts down, the ePump will continue to run for 30 minutes, and the ePump Controller will display **PUMP WILL REMAIN ON FOR XX:XX**, where **XX:XX** is the time remaining until ePump shutdown.

Section 3. User Operation

3.1 OFF Mode

When the pump is off (not running), the controller displays **PRESS PRESET OR MENU/00:00 PUMP IS OFF**, where 00:00 is the time-of-day clock.

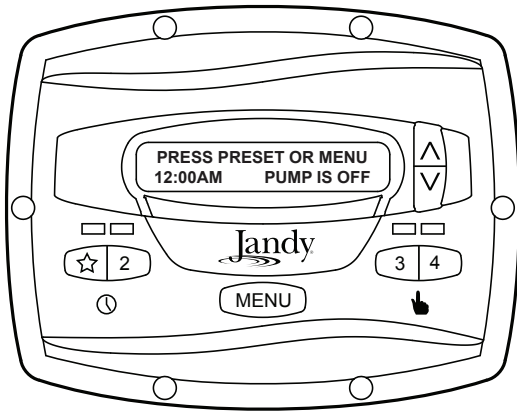

3.2 RUN Mode

When the pump is running (not off), the controller displays **N:LABEL/00:00 RPM:XXXX**, where n:label is the number and label of the selected preset, 00:00 is the time-of-day clock, and xxxx is the pump speed.

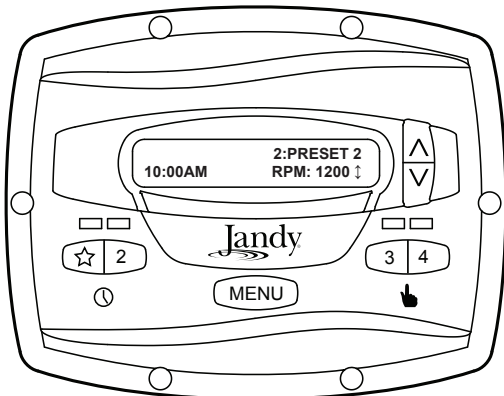

3.3 Manual Start and Stop

Up to eight (8) programmed speeds may be started from the controller. Manual operation of speeds "eStar" through "4" differs from manual operation of speeds "5" through "8".

NOTE When starting the pump, the pump will first run at the priming speed for the priming duration, as set by the installer.

3.3.1 Speeds eStar through 4

To start the pump manually running at speeds "eStar" through "4", press button "☆" through "4" corresponding to the desired speed. The associated LED will light red and the controller enters the **RUN** mode.

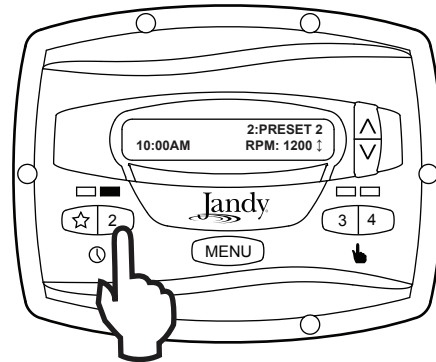

To stop the pump, press the button again. The associated LED will extinguish and the pump and controller will return to the **OFF** mode.

3.3.2 Speeds 5 through 8

To start the pump manually at speeds "5" through "8", press the **MENU** button. The controller displays **SELECT PRESET/N:LABEL**, where n:label is the number and label of the last selected preset "5" through "8".

Using the arrow keys, select the desired preset to activate, and then press **MENU** to enter **RUN** mode, starting the pump running at the selected speed.

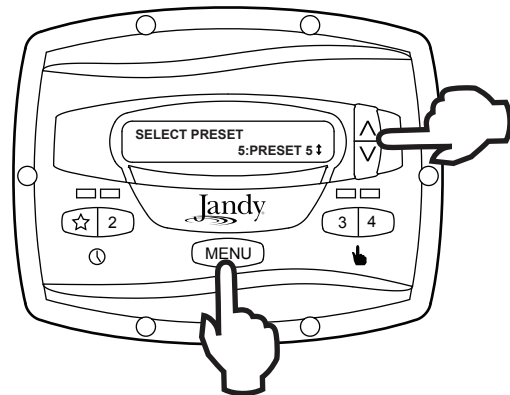

To stop the pump, press **MENU**. To exit without starting the pump, press any button "☆" through "4".

3.4 Pump Speed Setting

With the exception of preset "☆", the pump speed for each preset may be adjusted while the pump is running in that preset mode. Preset "☆" is reserved for the eStar function, and its speed is set by the installer.

To adjust the pump speed, the controller must be in the **RUN** mode. While in **RUN** mode, the controller displays the pump speed. Adjust the speed by pressing the up or down arrow keys. The speed is saved by the controller and will remain until changed again.

NOTE Pump speed is adjustable only within a certain range. The minimum and maximum limits of the range are set by the installer.

NOTE When used with a solar system, set speed to at least 3000 RPM and potentially up to 3450 RPM, based on the pump's head required to push the water up a minimum of 12-15 feet.

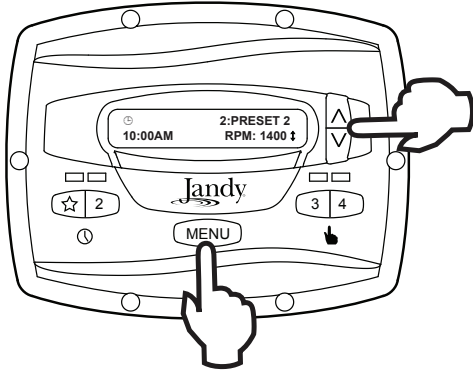

3.5 Timeclock Setup and Operation

The controller allows the user to create timed pump programs on pump speeds (presets) "☆" and "2". The two timers operate independently of each other, and may overlap in time if desired.

3.5.1 Timeclock Setup

Start the desired speed, "☆" or "2". Press **MENU**. The controller enters the Timeclock setup mode. Using the arrow keys, select **ON TIME** and press **MENU**. Set the desired pump turn-on time using the arrow keys and press **MENU**. The time is stored. Select **OFF TIME** using the arrow keys and press **MENU**. Set the desired pump turn-off time using the arrow keys and press **MENU**. The time is stored.

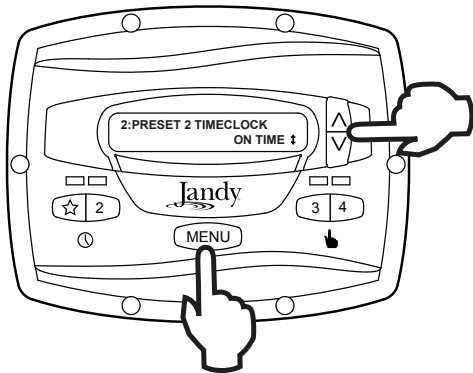

Using the arrow keys, select **TIMECLOCK**. Select **ENABLE** using the arrow keys. The program is now enabled to run. Press the preset button ("☆" or "2") to return to the **RUN** mode.

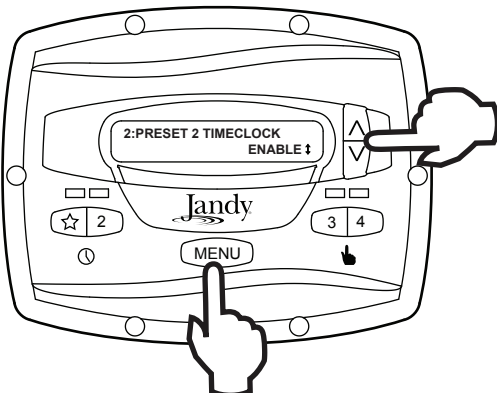

3.5.2 Timeclock Operation

When the pump is stopped, the associated green LED will illuminate, indicating a timeclock program is enabled for that speed.

If two (2) timed programs overlap, the program with the faster speed will take priority and run to completion. If the earlier-starting program is still active, it will resume operation.

The program off times never change, i.e., they are not 'pushed-out' in time when programs overlap. Timeclock programs may be prematurely stopped by stopping the pump manually from the keypad. This override is active until the program start time is reached again, at which time the timed program will start the pump as programmed.

If the pump is started manually at a speed that has been programmed with a timer, the pump will be stopped by the timeclock at the programmed off time.

NOTE When starting the pump via a timed program, the pump will first run at the priming speed for the priming duration, as set by the installer. If a program overlap occurs, the pump will immediately start at the program speed without priming first.

3.5.3 Manually Overriding a Timer Program

Timeclock programs may be prematurely stopped by pressing the active preset key. This override is active until the program start time is reached again, i.e., for 24 hours, at which time the timed program will start the pump as programmed.

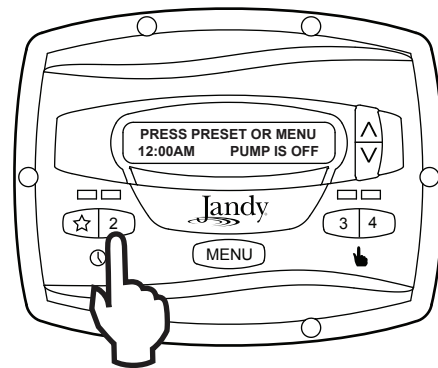

3.5.4 Timer Overriding a Manual On

If the pump is started manually at a speed that has been programmed with a timer, the pump will be stopped by the timeclock at the programmed off time. A clock icon appears on the display when the timer has assumed control of the off time.

Section 4. Service Setup Options

The service setup menu allows the installer to set various operating parameters, view fault history, and restore factory defaults.

Parameters that may be modified and set in the service setup menu include:

- Priming speed and duration.
- Minimum and maximum pump speeds.
- "☆" eStar speed.
- Pump Freeze Protect operation.

4.1 Entering Service Setup

NOTE The ePump controller must be in the OFF mode (all LED's lights must be off) before entering the user setup mode. While in setup mode the controller will return back to the OFF mode after one (1) minute since the last key press.

To enter the service setup menu, press and hold **MENU**, then press and hold the "☆" and preset "4" keys. Hold all three (3) keys down for five (5) seconds. To exit, press any preset button.

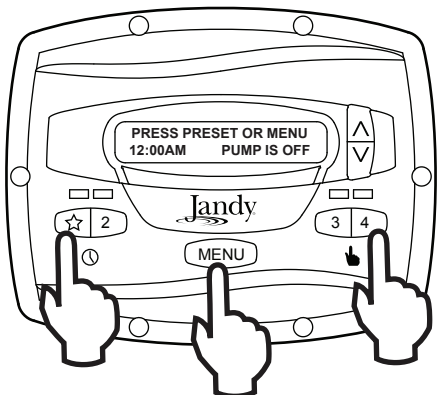

4.2 Minimum and Maximum Pump Speeds

These speeds are considered global settings across the entire controller, and create the range of allowable speed that may be sent to the ePump.

To set the minimum speed, from the service setup menu, select **SET MIN LIMIT** using the arrow keys. Press **MENU**. Using the arrow keys, set the minimum speed to the desired value. Press **MENU** to accept and store.

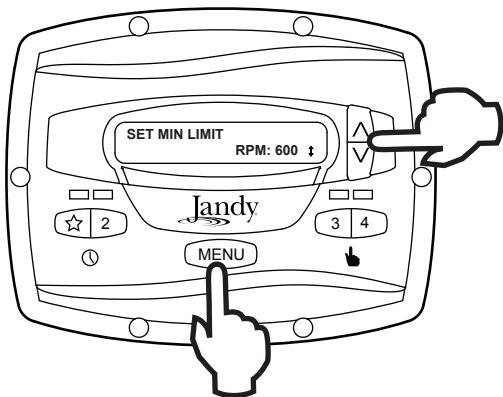

To set the maximum speed, from the service setup menu, select **SET MAX LIMIT** using the arrow keys. Press **MENU**. Using the arrow keys, set the maximum speed to the desired value. Press **MENU** to accept and store.

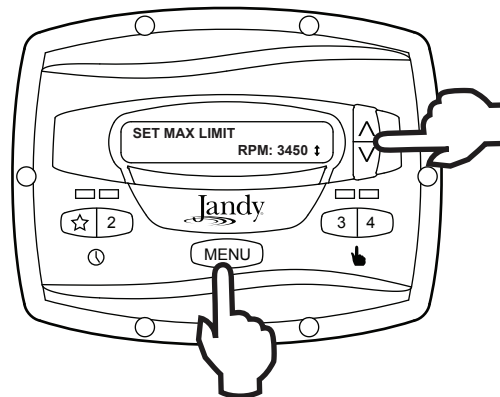

4.3 Load Defaults

To restore factory default settings to the controller, from the service setup menu, select **LOAD DEFAULTS**. Press **MENU**. Using the arrow keys, select **YES**. Press **MENU** to restore factory default settings.

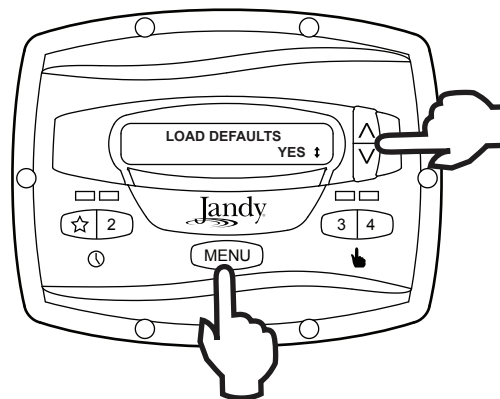

Default Speeds	
eStar	1750 RPM
Preset 2 - 8	2750 RPM
Priming Speed	2750 RPM
Other Defaults	
Freeze Protect Duration	30 min
Priming Duration	1 min

4.4 Last Fault

This feature shows on the top display line, the most recent unique fault message and on the bottom display line, the second-to-last unique fault message. If there is no entry for a fault, the display will show "*-----*" on the corresponding line. To select last fault, from the service setup menu select **LAST FAULT**. Press **MENU**.

NOTE The fault messages are stored in non-volatile memory, and remain even with no power. To clear the fault history, press either arrow key.

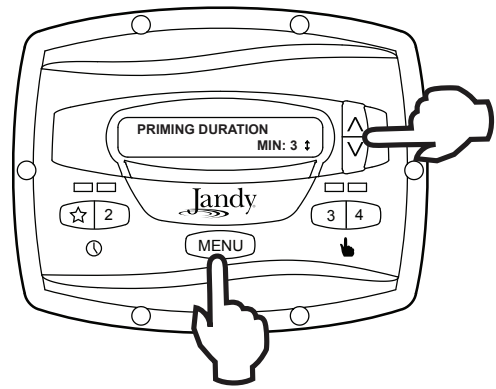
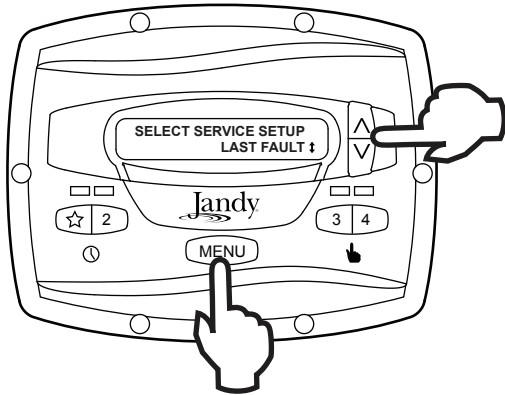

4.5 Priming Speed and Duration

The ePump controller will command the ePump to operate at the priming speed for the priming duration specified (except during timer program overlaps or follow-on commands where the pump is not stopped before changing speeds). From the service setup menu, select **PRIMING** using the arrow keys. Press **MENU**.

4.6 eStar Speed

The "☆" speed is intended to be used as an energy-efficient setting that can be easily called-up by activating the eStar preset speed from the keypad or remote closure. After this speed has been determined by the installer, the eStar preset may be set as follows: From the service setup menu, select **SET ESTAR SPEED**. Press **MENU**. Using the arrow keys, set the speed to the desired value. Press **MENU** to accept and store.

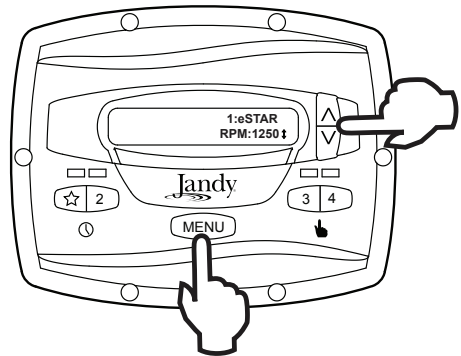
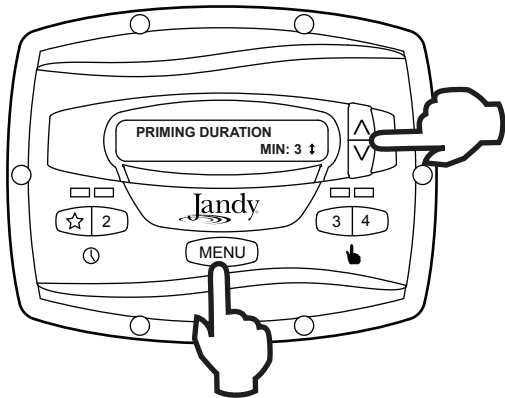

To set priming speed, select **PRIMING SPEED** using the arrow keys. Press **MENU**. Using the arrow keys, set the priming speed to the desired value. Press **MENU** to accept and store.

4.7 Pump Freeze Protect Operation

When enabled to do so, the ePump controller monitors the temperature inside the pump and will activate the ePump at the eStar speed when the temperature approaches freezing. The run duration of the pump freeze protect operation is adjustable from 30 minutes to 8 hours, or may be disabled completely.

To set the pump freeze protect operation, from the service setup menu select **PUMP FREEZE PROTECT**. Press **MENU**. Using the arrow keys, set the duration to the desired value. To disable pump freeze protect, set the duration to 0:00. Press **MENU** to accept and store.

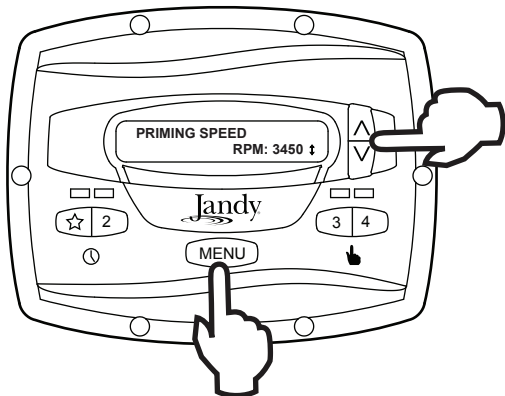

To set priming duration, select **PRIMING DURATION** using the arrow keys. Press **MENU**. Using the arrow keys, set the priming speed to the desired value in minutes from one (1) to five (5) minutes. Press **MENU** to accept and store.

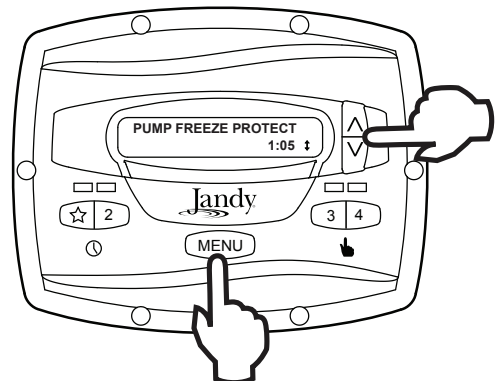

Important Information on Freeze Protection

Freeze protection is intended to protect equipment and plumbing for short periods of freezing only. It does this by activating the filtration pump and circulating the water to prevent freeze inside equipment or plumbing. Freeze protection does **not** guarantee that equipment will not be damaged by extended periods of freezing temperatures or power outages. In these conditions, the pool and spa should be shut down completely (e.g. drained of water and closed for the winter) until warmer weather exists.

The pump freeze protect run time may be interrupted by pressing a preset key, as follows:

Pressing the key "☆" once overrides the pump freeze protect run time, pressing it twice turns off the pump. Pressing other preset keys will override the pump freeze protect run time and activate the selected preset speed.

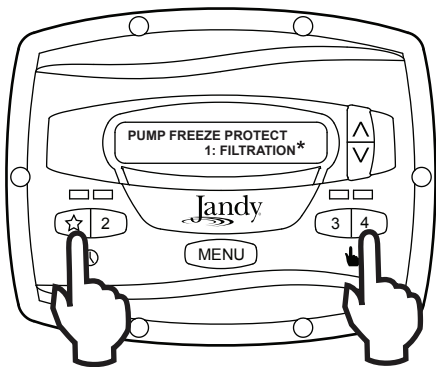

4.8 Selecting Pump Type

The ePump controller may be used to operate various types of pumps. It is important to select the correct pump type at this menu item to ensure proper controller operation.

From the setup menu, select **PUMP TYPE**. Press the **MENU** button to display the currently selected pump type. Using the arrow keys, choose the pump type that matches the type of the installed pump. Refer to the pump manual for information regarding the pump type.

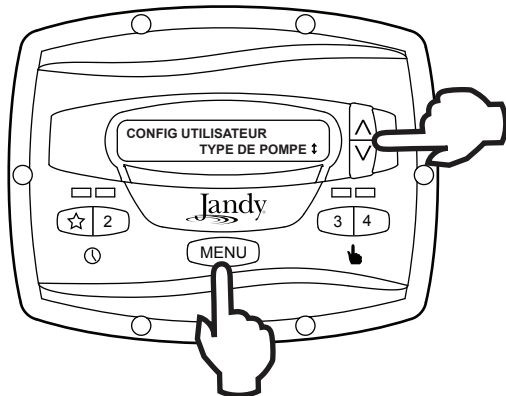

4.9 Display Power Usage

The ePump controller can alternately display the ePump power usage while the pump is in operation and the controller is in Run Mode.

To enable the power display feature, from the service setup menu select **DISPLAY POWER USAGE**. Press **MENU** to select. Using the arrow keys, select **YES**. Press **MENU** to accept and store.

To disable the power display feature, from the service setup menu select **DISPLAY POWER USAGE**. Press **MENU** to select. Using the arrow keys, select **NO**. Press **MENU** to accept and store.

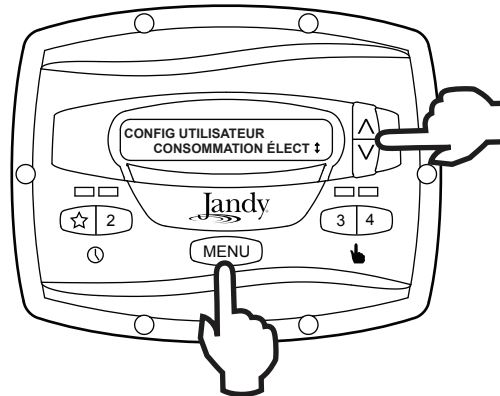

Section 5. User Set Up Options

NOTE The ePump controller must be in the OFF mode before entering the user setup mode. While in setup mode the controller will return back to the OFF mode after one (1) minute since the last key press.

When in setup mode, preset keys "☆" through "4" are used as 'escape' or exit keys while navigating the setup menu.

To enter the setup mode, press and hold the **MENU** button for five (5) seconds. The controller displays **SELECT USER SETUP**. Using the arrow keys, select the desired setup item to change.

5.1 Setting Time-of-Day

From the Setup menu, select **SET TIME**. Press the **MENU** button to display the currently-set time. Using the arrow keys, adjust to the desired time. Press **MENU** to save your setting.

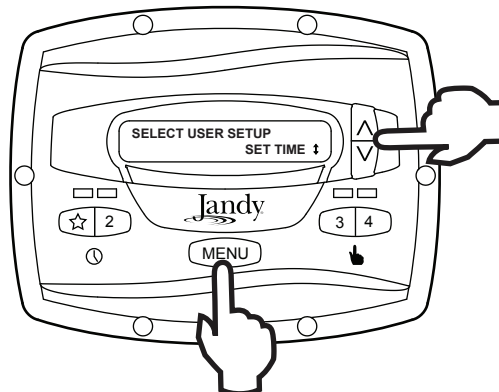

5.2 Labeling Presets

The ePump controller comes from the factory with pre-programmed labels or names for the preset speeds. The labels may be changed as desired to suit your particular installation.

Two (2) types of labels are provided by the controller:

- General Labels - selected from a list
- Custom Labels - created by the user

From the setup menu, select **LABEL PRESET**. Press the **MENU** button to display the currently selected Preset. Using the arrow keys, choose the preset to be changed. Press **MENU** to select. The controller displays **SELECT LABEL TYPE**. Select **GENERAL** or **CUSTOM** as desired using the arrow keys.

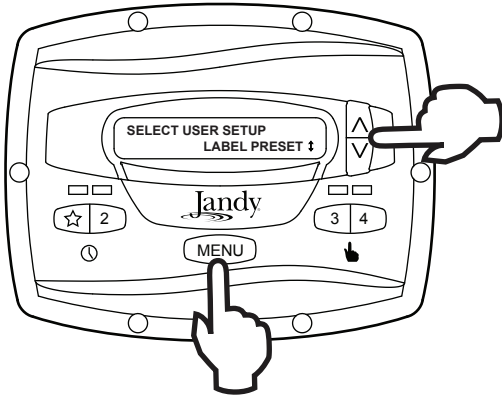

5.3 General Labels

Using the arrow keys, select a general label from the list to assign to the Preset. Press **MENU** to assign the label to the Preset.

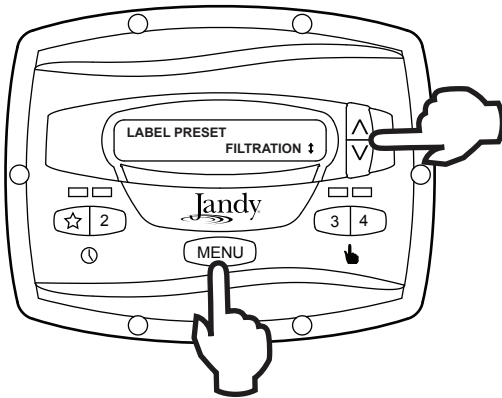

5.4 Custom Labels

In the custom label mode, the controller displays a flashing cursor at the character position to be changed. Using the arrow keys, change the character as desired. Press **MENU** to accept the change and advance to the next character position. Press any preset key "☆" through "4" to return to the previous cursor position.

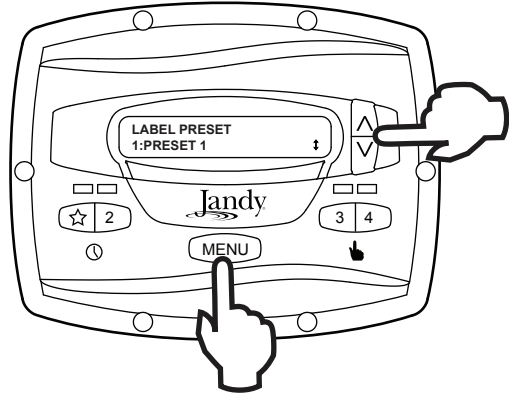

Continue this procedure until the end of the label is reached. The new label is saved when **MENU** is pressed at the last character position.

5.5 Display Light Control

The controller's display is equipped with a backlight to aid viewing in low light conditions.

From the setup menu, select **DISPLAY LIGHT**. Press **MENU**. Using the arrow keys, select the desired operating mode for the display backlight:

LIGHT OFF: Turn off display backlight.

LIGHT ON: Turn on display backlight.

2 MIN TIMEOUT: Turn on display backlight, with automatic turn-off after two (2) minutes since the last key press.

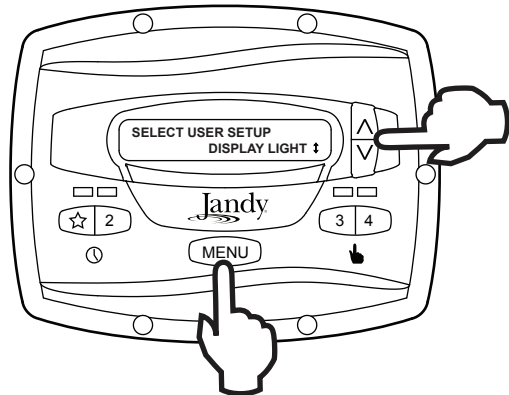

5.6 Language Selection

From the setup menu, select **LANGUAGE** using the arrow keys. Press **MENU**. Using the arrow keys, select the desired language. Press **MENU** to save the selection.

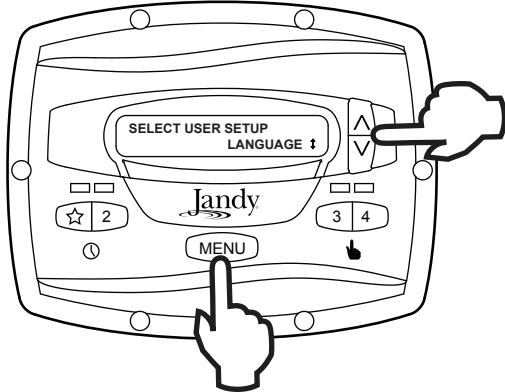

5.7 Run Duration (Presets 3 and 4 Only)

Presets "3" and "4" may be programmed to run for a specified duration after being manually started. This run duration is programmable from 30 minutes to eight (8) hours, in increments of 30 minutes. A setting of 0:00 disables the run duration feature, allowing the preset to run indefinitely.

From the setup menu, select **RUN DURATION**. Press **MENU**. Using the arrow keys, select the preset to be programmed. Press **MENU**. Set the desired run duration for the preset using the arrow keys. Press **MENU** to accept.

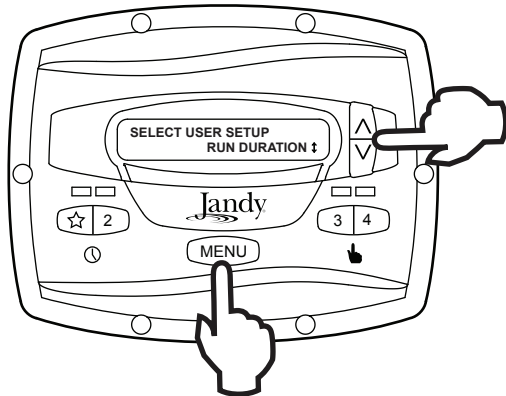

5.8 Scale

NOTE This selection may not appear as part of the setup menu depending on the type of pump connected.

If the connected pump is capable of flow control, the **SCALE** menu may be used to select flow or speed operation.

From the setup menu, select **SCALE**. Press the **MENU** button to display the currently selected scale. Using the arrow keys, choose the scale that corresponds to the type of control desired.

A setting of RPM allows control by speed, while a setting of GPM allows control by flow. Press **MENU** to select the scale.

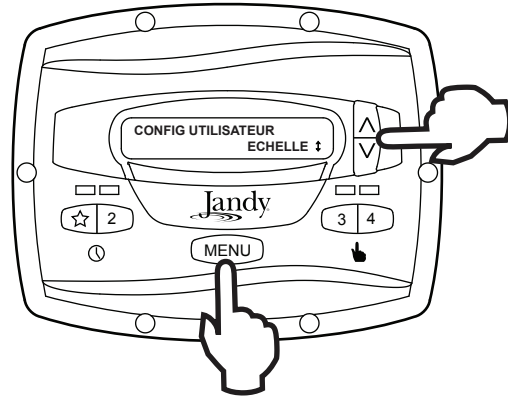

Section 6. Menu Flow Chart

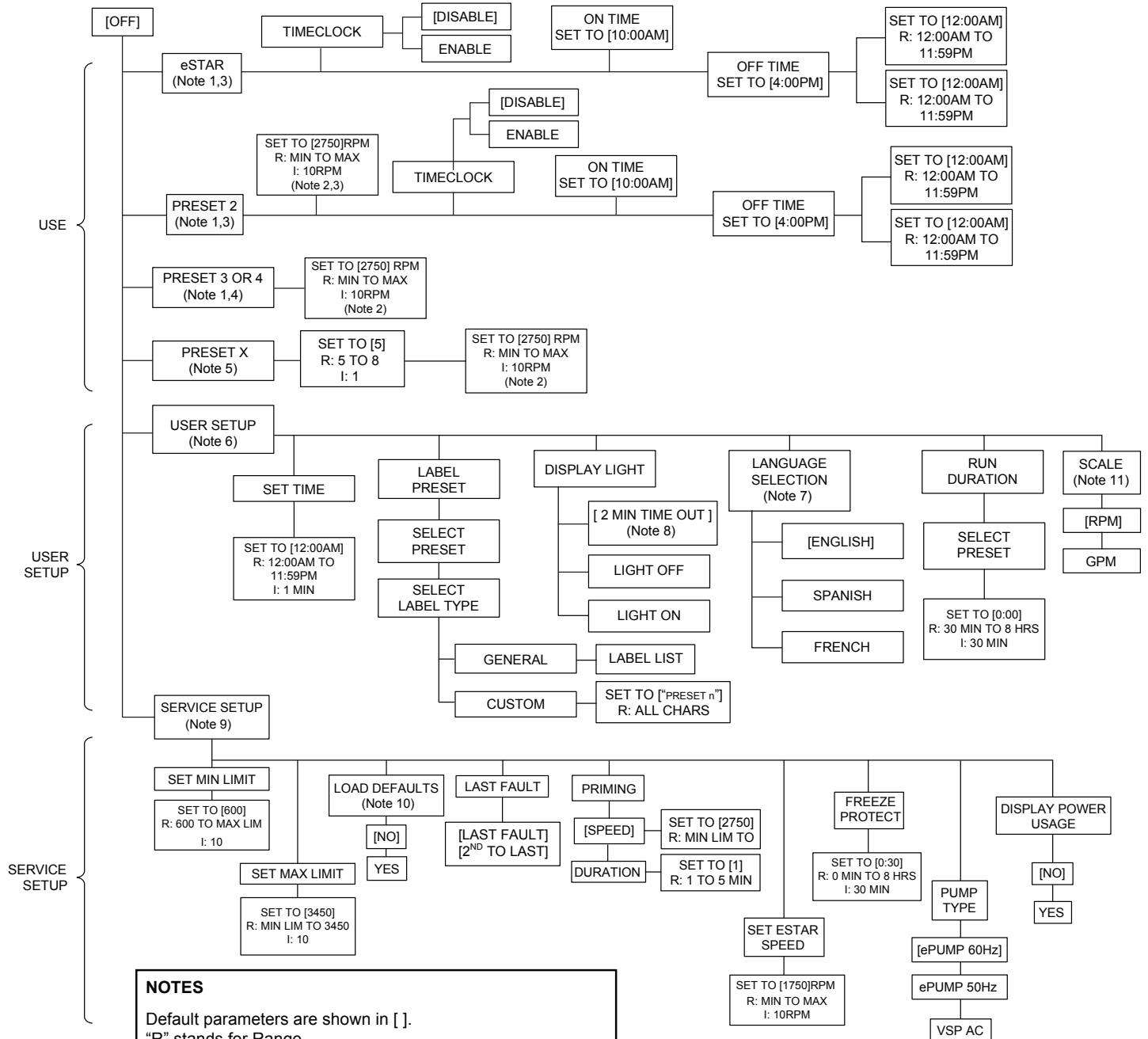

NOTES

Default parameters are shown in [].
 "R" stands for Range.
 "I" stands for Increment.

1. Accessed directly by front panel button.
2. Occurs at Run Screen.
3. Timeclock features accessed via MENU button while Preset is running.
4. MENU button has no effect when running.
5. Accessed via MENU button when pump is stopped.
6. Press and hold MENU button for five (5) seconds to enter.
7. Is not affected when "LOAD DEFAULTS" is executed.
8. Key that is pressed to wake up display is also acted upon.
9. Press and hold MENU, eStar, and 4 simultaneously for five (5) seconds to enter.
10. Setting not saved in non-volatile memory; reset to "NO" after execution.
11. Only appears when connected to pump capable of flow control.

