

Jandy®

DROP IN REPLACEMENT GUIDE

VS PUMPS



OFFICIAL
POOL
EQUIPMENT
SUPPLIER



Why Jandy®?

Why settle for sufficient when you can get superior...

With Jandy equipment, you're getting a product that's easy to install on most pool pads, compatible with most existing setups and provides unparalleled performance and efficiency.

TRADE SERIES
EXCLUSIVE

Protecting Your Bottom Line

We've got your back. Our equipment is **NOT** available for purchase on the internet. Only through you.

Drops In with Ease

Jandy equipment is engineered to easily replace most existing equipment on the pool pad with little to no plumbing adjustments. Jandy is a trade-up, not just a trade out.





Built to Last

Our equipment is designed for durability so you can get the job done and can trust that it will perform for the long haul.



Support You Can Count On

With our superior customer service and dedicated training team available to you when you need it most, you'll never be caught off guard on-site.

Why Jandy® VS FloPro™ is the First Choice When Replacing a Pump

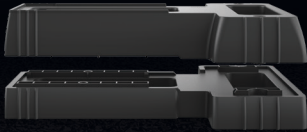

The Right Dimensions

Jandy VS FloPro pumps include an adjustable base so you can be certain the plumbing lines up to the Pentair® or Hayward® pump you're replacing.



Small for Service

No need to make more room. At just 24.5" long, Jandy VS FloPro pumps take up less space in your truck and on the equipment pad.



Everything You Need

VS FloPro pumps include 2" unionized fittings or utilize the 2" internal threads. Using the unionized fittings is recommended as they allow for micro adjustments for the perfect drop-in fit and make future maintenance easier.

115V



230V

The Power Play

Whether the pre-existing pump is wired for 230V or 115V, it doesn't matter with Jandy "Dual Voltage" Series VS FloPro pumps. They feature an autosensing, dual-voltage design that allows them to work with both — without having to rewire.

VS FloPro™ Dual-Voltage Pump Models

Standout Features

- A full-featured variable-speed pump lineup that combines performance with value
- 1.30, 1.65 and 1.85 HP Models
- SpeedSet™ VS Controller Preinstalled
- 2" Unionized Fittings + 2" Internal Threads
- 115V/230V Autosensing Operation

VS FloPro 1.3 HP Pump Curves

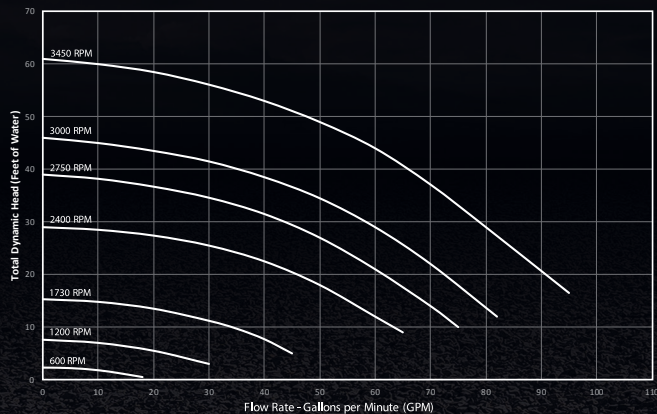

VS FloPro™ 1.65 HP Pump Curves

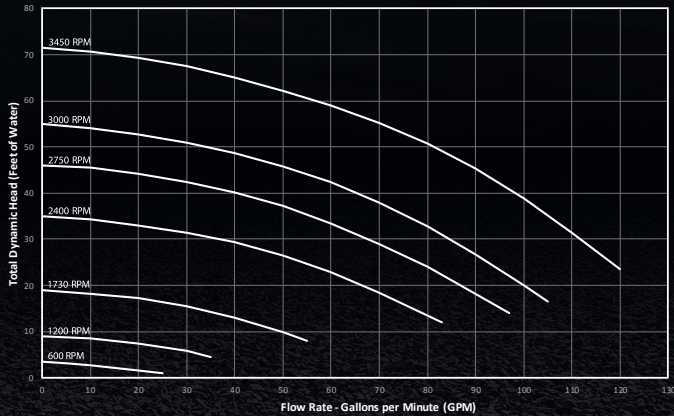

VS FloPro 1.85 HP Pump Curves

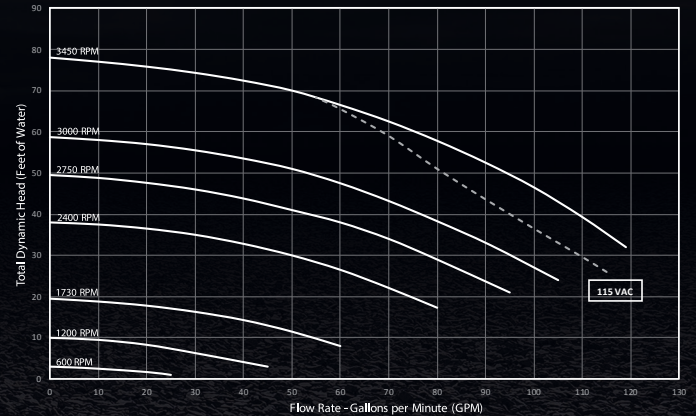

Specifications	THP	WEF	Voltage	Max Watts	Amps
VSFHP130DVS	1.30	11.0	230V	1,100W	8.6
		10.9	115V		15.6
VSFHP165DVS	1.65	9.0	230V	1,700W	10.5
		9.1	115V		17.7
VSFHP185DVS	1.85	8.2	230V	1,875W	13.5
		8.6	115V		17.4

VS FloPro™ Dual-Voltage, 2-Aux Relay Pump Models



Standout Features

- 1.85 And 2.7 HP Models
- SpeedSet™ VS Controller Preinstalled
- 2" Unionized Fittings + 2" Internal Threads
- 115V/208-230V Autosensing Operation
- Two Programmable Auxiliary Relays
- 4-Speed Dry Contact Relay Control
- Zero-Clearance TEFC Motor Design

VS FloPro™ 1.85 HP Pump Curves

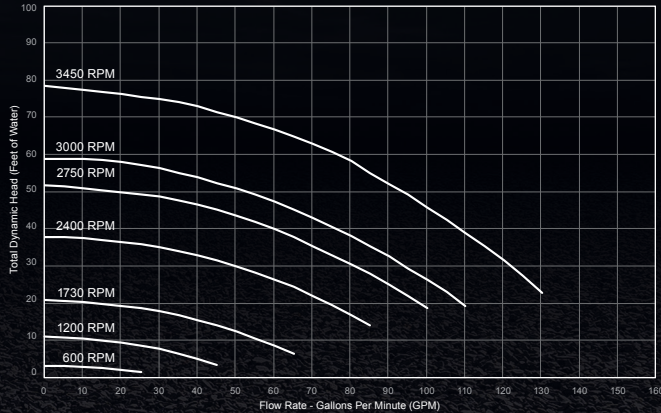

VS FloPro 2.7 HP Pump Curves

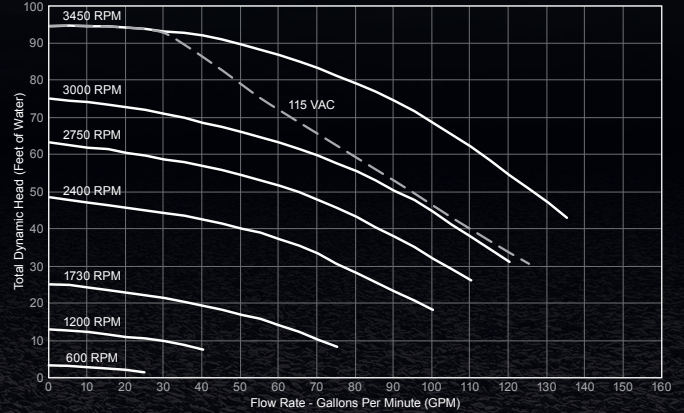

Specifications	THP	WEF	Voltage	Max Watts	Amps
VSFHP185DV2AS	1.85	8.5	208-230V 115V	1,700W 1,800W	8.5-8.0 15.5
VSFHP270DV2AS	2.70	7.3 8.7	208-230V 115V	2,550W 1,840W	11.5-10.5 16.0

VS FloPro™ 3.8 HP, 2-Aux Relay Pump



Standout Features

- 3.8 THP Variable-Speed Pump
- Drop-in Replacement for Pentair® IntelliFlo® VSF 3.95 HP Pump
- SpeedSet™ VS Controller Preinstalled
- 2" Unionized Fittings + 2" Internal Threads
- Two Programmable Auxiliary Relays
- 4-Speed Dry Contact Relay Control
- Zero-Clearance TEFC Motor Design

VS FloPro™ 3.8 HP Pump Curves

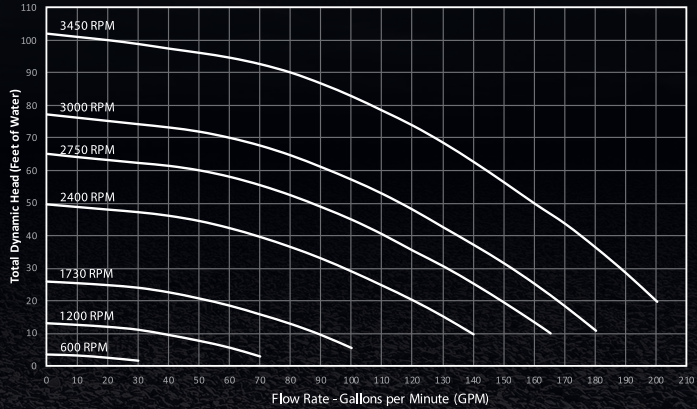

VS FloPro 3.8 vs. IntelliFlo VSF 3.95

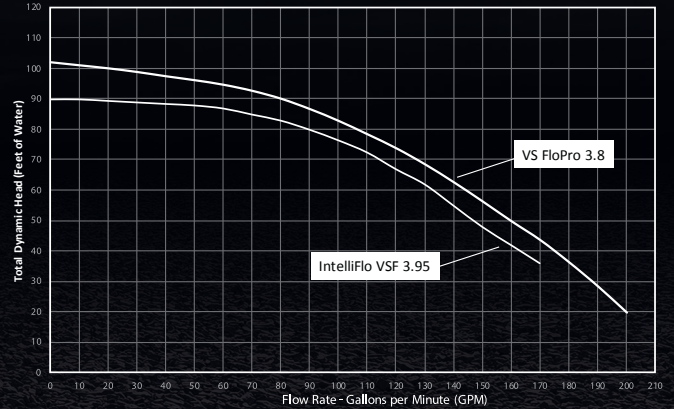

Specifications

VSFHP3802AS

THP

3.80

WEF

6.0

Voltage

208-230V

Max Watts

3,250W

Amps

16.0

Using the Adjustable Base with Spacers

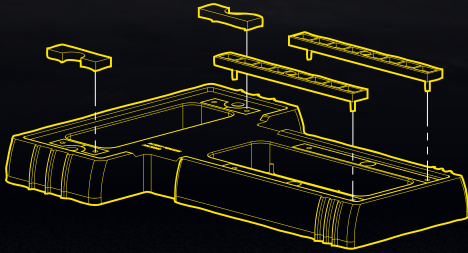

The small base + spacers are used when replacing a Pentair® WhisperFlo®, IntelliFlo® VSF, or Sta-Rite® Dyna-Glas® pump.

1. Use a cutting tool to remove the spacers from the base.
2. Insert the pins on the spacers into the holes on the base as shown above.



When Replacing...

Hayward® Super Pump®

Pentair® SuperFlo®

Sta-Rite® SuperMax®

No Base Required



Hayward Super II®

Jandy® PlusHP

Jandy Max® HP



Small Base



Pentair WhisperFlo®

Pentair IntelliFlo VSF®

Sta-Rite Dyna-Glas®

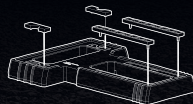

Small Base with Spacers

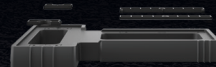

Sta-Rite® Max-E-Pro®

Sta-Rite Dura-Glas®

Sta-Rite Dura-Glas II®

Sta-Rite Max-E-Glas®

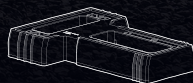

Small Base + Large Base*



*Large Base R-kit part number R0546400 is sold separately. Small base with spacers included with every VS FloPro pump.

Dimension Comparison: VS FloPro and WhisperFlo / IntelliFlo VSF

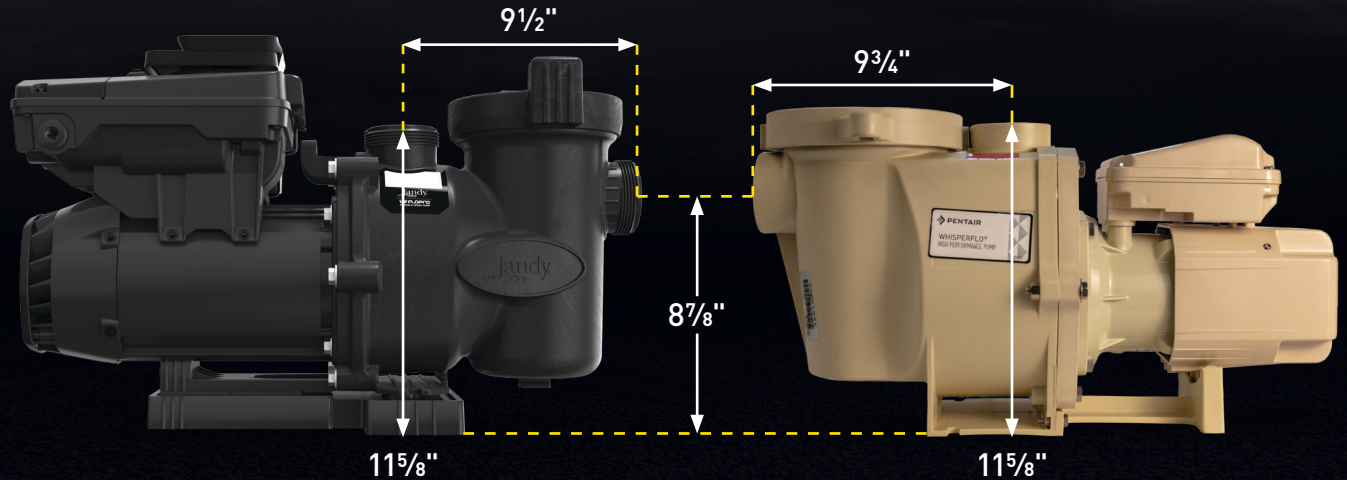

Jandy® VS FloPro™
w/ Small Base + Spacers

Pentair® WhisperFlo® and IntelliFlo® VSF 3.95 HP

Pentair® WhisperFlo® / IntelliFlo® Models and Recommended VS FloPro™ Replacement Models

Pentair® Item Number	Pentair® Model	HP	SF	THP	Power	Length	Jandy® VS FloPro Equivalent Models
011511	WFE-2	0.50	1.90	0.95	115V/230V	24.5"	VSFHP185DVS or VSFHP185DV2AS
011578	WF-2	0.50	1.90	0.95	115V/230V	24.5"	
011771	WF-23	0.75	1.25	0.95	115V/230V	24.5"	
011512	WFE-3	0.75	1.67	1.25	115V/230V	24.5"	
011517	WFE-24	0.75	1.25	1.25	115V/230V	24.5"	
011579	WF-3	0.75	1.67	1.25	115V/230V	24.5"	
011772	WF-24	1	1.25	1.25	115V/230V	24.5"	
012530	WFDS-3	0.75	1.67	1.25	115V	24.5"	
012485	WFDS-24	1	1.25	1.25	115V	24.5"	
011513	WFE-4	1	1	1.65	115V/230V	24.7"	
011518	WFE-26	1.5	1.1	1.65	115V/230V	24.7"	
011580	WF-4	1	1.65	1.65	115V/230V	24.7"	
011773	WF-26	1.5	1.1	1.65	115V/230V	24.7"	
011641	WFK-4	1	1.65	1.65	230V/460V	24.7"	
011486	WFDS-4	1.5	1.47	2.2	230V	24.7"	
012518	WFDS-26	1.5	1.65	1.65	230V	24.7"	
011514	WFE-6	1.5	1.47	2.2	230V	25.2"	
011519	WFE-28	2	1.1	2.2	230V	25.2"	
011581	WF-6	1.5	1.5	2.2	115V/230V	25.2"	
011774	WF-28	2	1.1	2.2	115V/230V	25.2"	VSFHP270DV2AS
011642	WFK-6	1.5	1.47	2.2	230V/460V	25.2"	
011522	WFDS-6	1.5	1.47	2.2	230V	25.2"	
011524	WFDS-28	2	1.1	2.2	230V	25.2"	
011515	WFE-8	2	1.3	2.6	230V	25.7"	
011520	WFE-30	2.5	1.04	2.6	230V	25.7"	
011582	WF-8	2	1.3	2.6	230V	25.7"	
011775	WF-30	2.5	1.04	2.6	230V	25.7"	
011643	WFK-8	2	1.3	2.6	230V/460V	25.7"	
011523	WFDS-8	2	1.3	2.6	230V	25.7"	
011525	WFDS-30	2.5	1.04	2.6	230V	25.7"	VSFHP3802AS
011516	WFE-12	3.0	1.15	3.45	230V	25.7"	
011530	WFET-12						
011583	WF-12						
011644	WFK-12						
011018	IntelliFlo® VS and IntelliFlo VSF	3.95	1.0	3.95	115V/230V	23.4"	

Dimension Comparison: VS FloPro and Super Pump

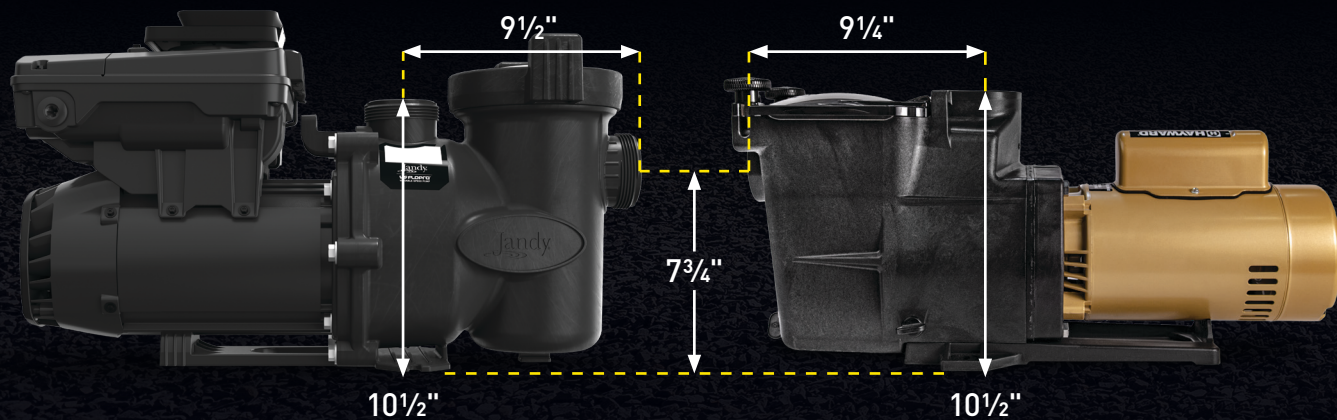

Jandy® VS FloPro™

Hayward® Super Pump®

Hayward® Super Pump® Models and Recommended VS FloPro™ Replacement Models

Super Pump Model (Single-Speed)	HP	SF	THP	Power	Port Size	Length	Jandy® VS FloPro™ Equivalent Models
SP2600X5	0.50	1.20	0.60	115V	1.5"	23"	VSFHP130DVS
SP2605X7	0.75	1.00	0.75	115V/230V	1.5"	23.75"	
SP2607X10	1.00	1.10	1.10	115V/230V	1.5"	24"	
SP2670007X10	1.00	1.10	1.10	115V/230V	1.5"	24"	
SP2610X15	1.50	1.00	1.50	115V/230V	1.5"	25.25"	VSFHP165DVS
SP2670010X15	1.50	1.00	1.50	115V/230V	1.5"	25.25"	
SP2621X25	2.50	1.00	2.50	230V	2"	26.25"	
SP2615X20	2.00	1.00	2.00	115V/230V	2"	25.75"	VSFHP270DV2AS
Super Pump Model (2-Speed)	HP	SF	THP	Power	Port Size	Length	Jandy® VS FloPro™ Equivalent Models
SP2607X102S	1.00	1.00	1.00	230V	1.5"	22.75"	VSFHP130DVS
SP2610X152S	1.50	1.00	1.50	230V	1.5"	23.5"	VSFHP165DVS
SP2615X202S	2.00	1.00	2.00	230V	2"	24"	VSFHP270DV2AS

Most Super Pump models utilize 1.5" threaded ports.
Use 2" to 1.5" slip reducers to utilize the Jandy 2" unionized fittings for perfect micro adjustments on existing plumbing.



DON'T LEAVE

MONEY

ON THE TABLE

SIGN UP TODAY &

GET THE **RIGHT TOOLS**

Fluidra's ServicePro rewards program is designed specifically for pool service companies and gives you access to the right tools, including marketing services, software, training and valuable consumer incentives — everything you need to grow your business.



Sign up now and unlock over **\$5,000** in value, including:



\$50 Sign-Up Bonus



\$200 Back On Each Automation - Max. 5



5% Back On First \$5,000



10% Back On First \$1,000 Of Select Parts



\$200 Back On Each VS Pump - Max. 5



Plus **Many More** Exclusive Benefits

Sign up today!



Program subject to change or cancellation without notice

#DropInAJandy

A Fluidra Brand | Jandy.com | 1.800.822.7933

©2025 Fluidra. All rights reserved. The trademarks and trade names used herein are the property of their respective owners. 27572_SA

