

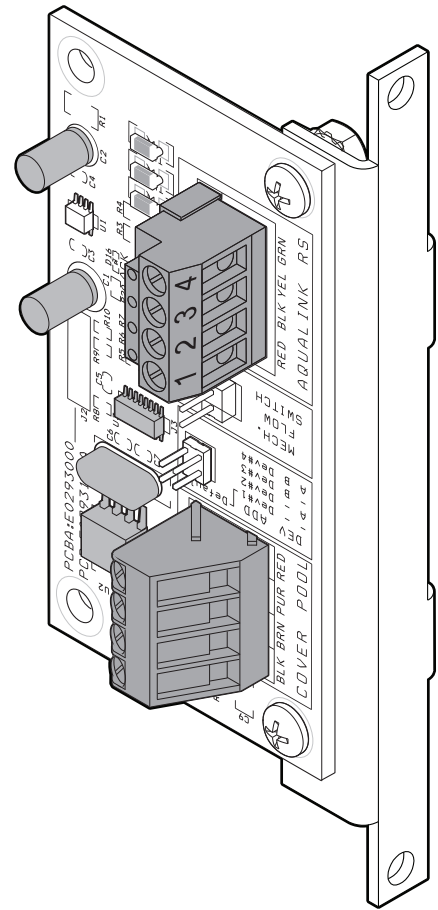

INSTALLATION AND OPERATION MANUAL



Cover-Pools®/AquaLink® RS Interface

For use with AquaLink RS OneTouch™ Systems with Rev R Firmware or later and Cover-Pools Auto-Shutoff Controller

⚠ WARNING

FOR YOUR SAFETY - This product must be installed and serviced by a contractor who is licensed and qualified in pool equipment by the jurisdiction in which the product will be installed where such state or local requirements exist. The maintainer must be a professional with sufficient experience in pool equipment installation and maintenance so that all of the instructions in this manual can be followed exactly. Before installing this product, read and follow all warning notices and instructions that accompany this product. Failure to follow warning notices and instructions may result in property damage, personal injury, or death. Improper installation and/or operation will void the warranty. Improper installation and/or operation can create unwanted electrical hazard which can cause serious injury, property damage, or death.

Table of Contents

Section 1. Important Safety Instructions.....	5
Section 2. System Overview.....	7
2.1 Cover-Pools/AquaLink RS Interface.....	7
Section 3. Cover-Pools/AquaLink RS Interface Installation	7
3.1 Power Center Bezel Installation	7
3.2 Low-Voltage Raceway Installation.....	8
3.3 Wiring the Cover-Pools/AquaLink RS Interface	8
Section 4. Cover-Pools/AquaLink RS Interface OneTouch™ and WebTouch Setup	10
4.1 Cover-Pools/AquaLink RS Interface SetupUp OneTouch	10
4.2 Cover-Pools/AquaLink RS Interface WebTouch Setup	11

Section 1. Important Safety Instructions

READ AND FOLLOW ALL INSTRUCTIONS

All electrical work must be performed by a licensed electrician and conform to all national, state, and local codes. When installing and using this electrical equipment, basic safety precautions should always be followed, including the following:

DANGER

To reduce the risk of injury, do not remove the suction fittings of your spa or hot tub. Never operate a spa or hot tub if the suction fittings are broken or missing. Never replace a suction fitting with one rated less than the flow rate marked on the equipment assembly.

WARNING

Prolonged immersion in hot water may induce hyperthermia. Hyperthermia occurs when the internal temperature of the body reaches a level several degrees above the normal body temperature of 98.6°F (37°C). The symptoms of hyperthermia include dizziness, fainting, drowsiness, lethargy, and an increase in the internal temperature of the body. The effects of hyperthermia include: 1) unawareness of impending danger; 2) failure to perceive heat; 3) failure to recognize the need to exit spa; 4) physical inability to exit spa; 5) fetal damage in pregnant women; 6) unconsciousness resulting in a danger of drowning.

WARNING

To Reduce the Risk of Injury -

- a) The water in a spa should never exceed 104°F (40°C). Water temperatures between 100°F (38°C) and 104°F (40°C) are considered safe for a healthy adult. Lower water temperatures are recommended for young children and when spa use exceeds 10 minutes.
- b) Since excessive water temperatures have a high potential for causing fetal damage during the early months of pregnancy, pregnant or possibly pregnant women should limit spa water temperatures to 100°F (38°C).
- c) Before entering a spa or hot tub, the user should measure the water temperature with an accurate thermometer since the tolerance of water temperature-regulating devices varies.
- d) The use of alcohol, drugs, or medication before or during spa or hot tub use may lead to unconsciousness with the possibility of drowning.
- e) Obese persons and persons with a history of heart disease, low or high blood pressure, circulatory system problems, or diabetes should consult a physician before using a spa.
- f) Persons using medication should consult a physician before using a spa or hot tub since some medication may induce drowsiness while other medication may affect heart rate, blood pressure, and circulation.

WARNING

Risk of electric shock - Install the power center at least five (5) feet (152.4cm) from the inside wall of the pool and/or hot tub using non-metallic plumbing. Canadian installations must be at least three (3) meters from the water. Children should not use spas or hot tubs without adult supervision.

Do not use spas or hot tubs unless all suction guards are installed to prevent body and hair entrapment.

People using medications and/or having an adverse medical history should consult a physician before using a spa or hot tub.

 **WARNING**

People with infectious diseases should not use a spa or hot tub.

To avoid injury, exercise care when entering or exiting the spa or hot tub.

Do not use drugs or alcohol before or during the use of a spa or hot tub to avoid unconsciousness and possible drowning.

Pregnant or possibly pregnant women should consult a physician before using a spa or hot tub.

Water temperature in excess of 100°F (38°C) may be injurious to your health.

Before entering a spa or hot tub measure the water temperature with an accurate thermometer.

Do not use a spa or hot tub immediately following strenuous exercise.

Prolonged immersion in a spa or hot tub may be injurious to your health.

Do not permit any electric appliance (such as a light, telephone, radio, or television) within 5 feet (1.5 m) of a spa or hot tub.

The use of alcohol, drugs or medication can greatly increase the risk of fatal hyperthermia in hot tubs and spas.

Water temperature in excess of 100°F (38°C) may be hazardous to your health.

 **WARNING**

To avoid injury ensure that you use this control system to control only packaged pool/spa heaters which have built-in operating and high limit controls to limit water temperature for pool/spa applications. This device should not be relied upon as a safety limit control.

 **CAUTION**

A terminal bar marked "GROUND" is provided within the power center. To reduce the risk of electrical shock, connect this terminal bar to the grounding terminal of your electric service or supply panel with a continuous copper conductor having green insulation and one that is equivalent in size to the circuit conductors supplying this equipment, but no smaller than no. 12 AWG (3.3mm). In addition, a second wire connector should be bonded with a no. 8 AWG (4.115mm) copper wire to any metal ladders, water pipes, or other metal within five (5) feet (1.52m) of the tub.

 **CAUTION**

A ground-fault circuit-interrupter must be provided if this device is used to control underwater lighting fixtures. The conductors on the load side of the ground-fault circuit-interrupter shall not occupy conduit, boxes, or enclosures containing other conductors unless the additional conductors are also protected by a ground-fault circuit-interrupter. Refer to local codes for complete details.



Attention installer: Install to provide drainage of compartment for electrical components.

SAVE THESE INSTRUCTIONS

Section 2. System Overview

The Cover-Pools/AquaLink RS interface is designed to let the AquaLink RS control systems know when the pool is closed so selected equipment can be turned off and/or the settings can be adjusted.

The Cover-Pools/AquaLink RS interface consists of one printed circuit assembly and can be mounted in any of these locations as best suitable for your system:

- (a) inside of the power center enclosure on the AquaLink RS bezel assembly as a daughter card,
- (b) or in the low-voltage raceway of the power center enclosure.

2.1 Cover-Pools/AquaLink RS Interface

The package of the Cover-Pools/AquaLink RS interface kit (see Figure 1) contains the following items:

1. A PCB Assembly mounted on a Mounting Bracket (Mounted at factory)
2. Two (2) Self-tapping Screws
3. Four (4) Wire Nuts

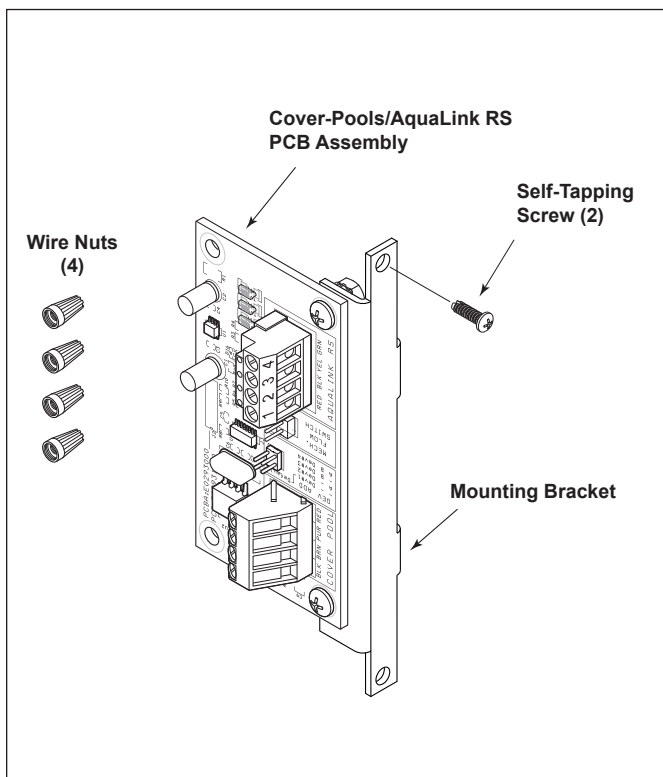

Figure 1. Cover-Pools/AquaLink RS Interface PCB Components

Section 3. Cover-Pools/AquaLink RS Interface Installation

⚠ WARNING

Risk of Electric Shock which can result In Serious Injury or Death. Before attempting installation or service, ensure that all power to the circuit supplying power to the system is disconnected or turned off at the circuit breaker.

All wiring must be done in accordance with the National Electrical Code® (NEC), NFPA-70®. In Canada, the Canadian Electrical Code® (CEC), CSA C22.1, must be followed. All applicable local installation codes and regulations must be followed.

3.1 Power Center Bezel Installation

1. Unscrew and remove the power center PCB and bezel assembly from the power center enclosure as shown in Figure 2.

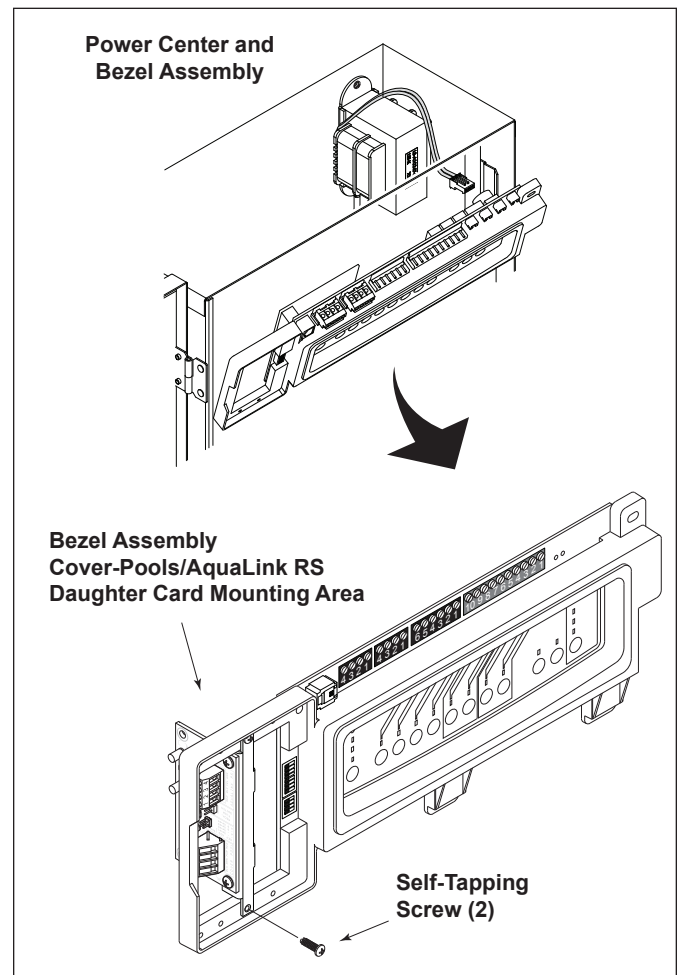

Figure 2. Installation of the Cover-Pools/AquaLink RS Interface Kit on the Bezel Assembly

- Secure the Cover-Pools/AquaLink RS interface board and mounting bracket to the daughter card mounting area in the bezel assembly with the two self-tapping screws provided.

NOTE Make sure that the top side of the Cover-Pools/AquaLink RS interface board faces left.

- Reinstall the power center PCB and bezel assembly in the power center enclosure using the screws previously removed.

3.2 Low-Voltage Raceway Installation

- If the daughter card area is not available or if the slots on the bezel assembly are all used, install the mounting bracket and Cover-Pools/AquaLink RS interface board in the low-voltage raceway of the power center.
- Secure the Cover-Pools/AquaLink RS interface board and mounting bracket inside of the power center enclosure in the low voltage raceway with the two self-tapping screws provided as shown in Figure 3.

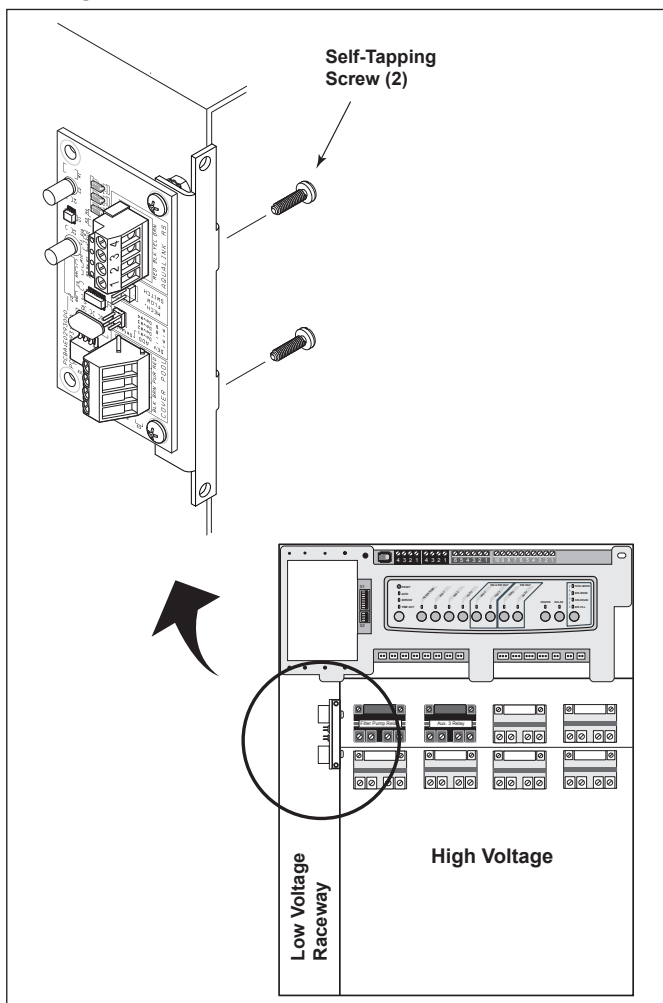

Figure 3. Installation of the Cover-Pools/AquaLink RS board in the Low-Voltage Raceway

3.3 Wiring the Cover-Pools/AquaLink RS Interface

⚠ WARNING

Potentially high voltages in the AquaLink RS power center can create dangerous electrical hazards, possibly causing death, serious injury or property damage. Turn off power at the main circuit feeding the AquaLink RS power center to disconnect the power center from the system.

3.3.1 Wiring the AquaLink RS PC Board

- Connect the RS485 communication cable to the red 4-pin terminal bar on AquaLink RS PC board. See Figure 4.
- Connect the other end the RS485 communication cable to the red 4-pin terminal bar (J1 connector) on the Cover-Pools interface board.

3.3.2 Wiring the Cover-Pools Controller

A 4-wire cable must be routed from the power center to the Cover-Pools controller through the knockouts of the low voltage raceway at the power center can bottom. See Figure 4.

- Make provision for the 4-wire cable to be run between the Cover-Pools controller and the power center.
 - Pull the 4-wire cable through the knockout with the Heyco® fitting and into the low voltage compartment.
- NOTE** Never run high voltage and low voltage in the same conduit.
- Strip ¼" of the insulation from each wire of the cable at both ends.
 - Connect the 4-wire cable to the 4-pin J5 connector on the Cover-Pools/AquaLink RS interface board.
 - Cut and strip the insulation from the four (4) wires of the accessory board control wiring and the keypad control wiring. See Figure 4.

- Using the included four (4) wire nuts, secure each wire of the cable from Cover-Pools/AquaLink RS interface board to the accessory board control wiring and the keypad control wiring. Make sure the colors of the wires match to each other when securing the wire nuts.

NOTE The wire color labels are stamped on the 4-pin J5 connector of the Cover-Pools AquaLink RS interface board.

NOTE: Occasionally, the motor directions, key switch or magnet may be wired opposite of normal. This could cause the **sensors to read opposite** (cover closed when open and vice versa). To switch the cover sensors, **exchange the purple and brown wires on the J5 connector.**

⚠ WARNING

In order to prevent drowning hazard, ensure that the motor directions, key switch and magnet are wired properly. If improperly wired, they may read "closed" when the cover is open or vice versa. If this is the case you must exchange the purple and brown wires on the J5 connector to correct the wiring.

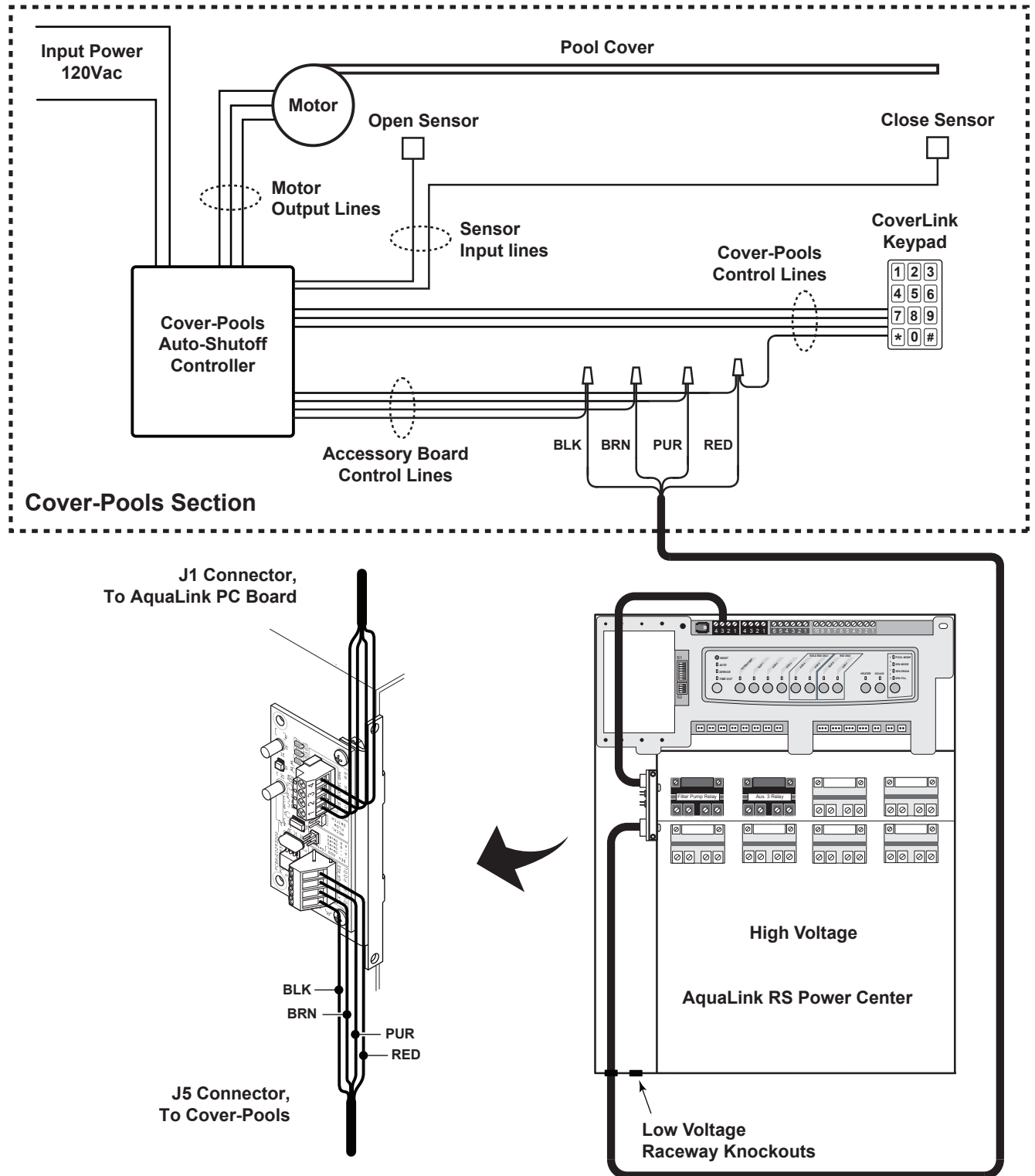

Figure 4. Wiring the Cover-Pools/AquaLink RS Interface Board

Section 4. Cover-Pools/ AquaLink RS Interface Setup

The Cover-Pools/AquaLink RS interface may be set up using the AquaLink RS OneTouch (Rev R and newer) or the iAquaLink™ WebTouch user interfaces (Rev S and newer).

4.1 Cover-Pools/AquaLink RS Interface Setup Using The OneTouch

On the HOME screen, use the UP/DOWN arrow keys to highlight MENU/HELP and press SELECT.

On the MENU screen, use the UP/DOWN arrow keys to highlight SYSTEM SETUP and press SELECT.

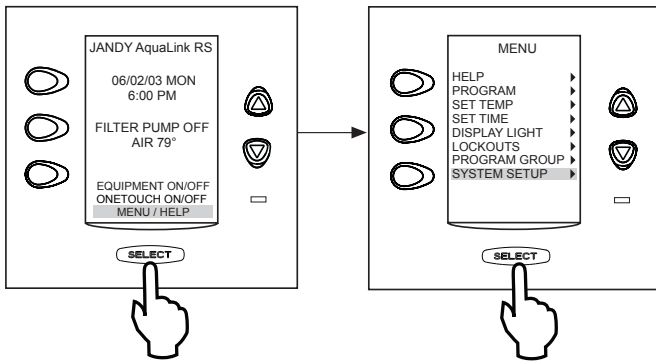

On the SYSTEM SETUP screen, use the PAGE UP and PAGE DOWN buttons to highlight COVER-POOLS.

Press SELECT to display the COVER-POOLS screen.

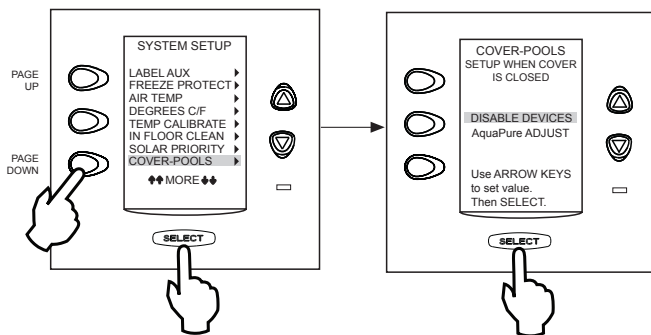

4.1.1 Disable Devices

On the COVER-POOLS screen, highlight DISABLE DEVICES and press SELECT.

On DISABLE DEVICES screen, use the UP/DOWN arrow keys to highlight the device and press SELECT to disable.

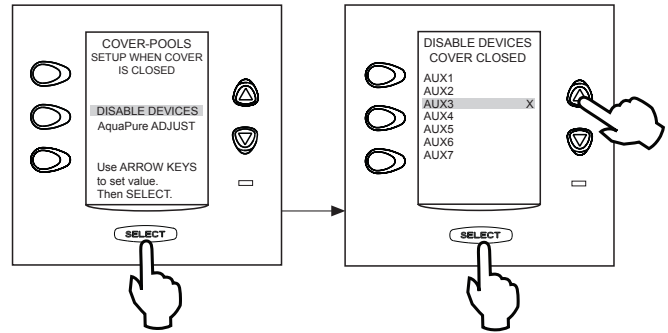

4.1.2 AquaPure® Adjust

On the COVER-POOLS screen, highlight AQUAPURE ADJUST and press SELECT to display the AQUAPURE ADJUST screen.

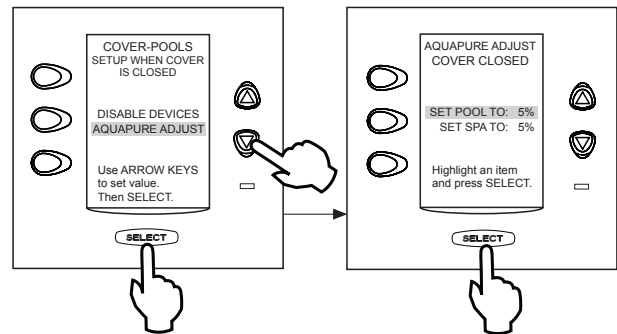

To change the SET POOL or SET SPA percentage on the AQUAPURE ADJUST screen, highlight either SET POOL or SET SPA and press SELECT.

An underscore line will blink under the percentage value, use the UP/DOWN arrow keys to change this value and press SELECT.

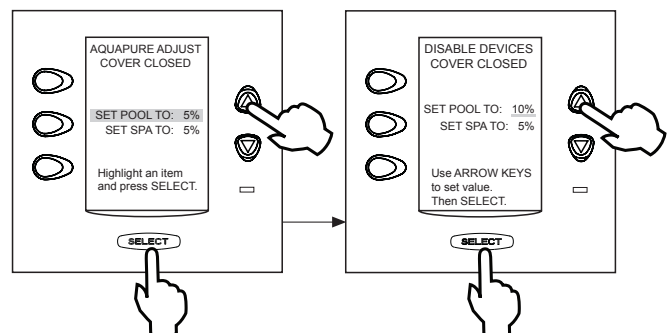

4.2 Cover-Pools/AquaLink RS Interface Setup Using The iAquaLink™ WebTouch. (AquaLink RS, Rev S and newer)

On the main system menu, touch or click the MENU button.

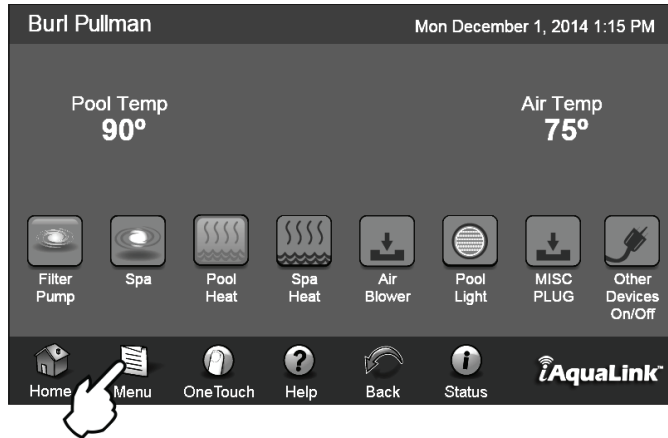

On the MENU screen touch or click SYSTEM SETUP.

On the SYSTEM SETUP screen touch or click COVER-POOLS.

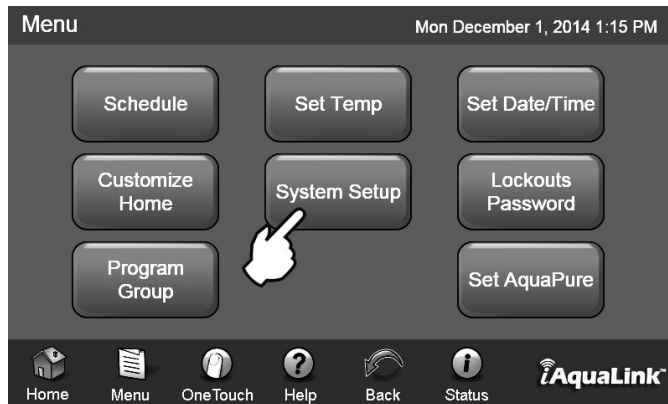

4.2.1 Disable Devices

On the COVER-POOLS SETUP screen you can select which devices are disabled when the pool is covered by touching or clicking the device from the DISABLE DEVICES list along the left side of the screen.

4.2.2 AquaPure® Adjust

You can adjust the AquaPure output percentage for both pool and spa by selecting POOL % or SPA % from the middle of the screen under AQUAPURE OUTPUT % then inputting the output percentage using the keypad under SET TO: on the right hand side of the screen.

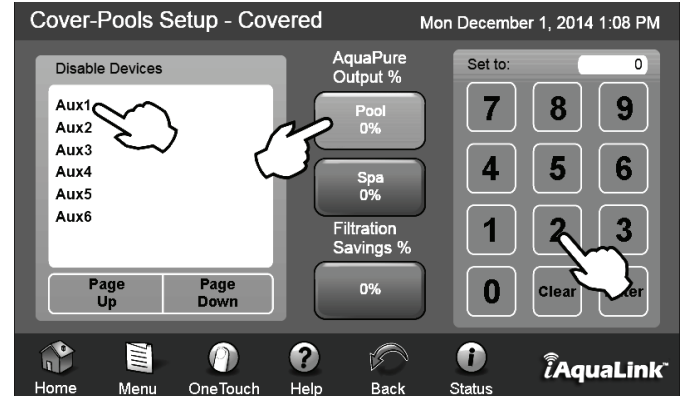

Zodiac Pool Systems, Inc.
2620 Commerce Way, Vista, CA 92081
1.800.822.7933 | www.ZodiacPoolSystems.com

ZODIAC® is a registered trademark of Zodiac International, S.A.S.U., used under license.
All trademarks referenced herein are the property of their respective owners.

©2014 Zodiac Pool Systems, Inc. H0370100_REVB